



EGLO

my light | my style



TREND & STYLE

COLLECTION

2024/25

INDUSTRIAL

4



LOFT

76



JAPANDI

180



NATURE

202



VINTAGE

240



ETHNO ELEGANCE

260



SOCKETS & ILLUMINANTS

270





INDUSTRIAL

#RAW
#BRICKS

Soft lines, playful curves and comfort? Certainly not. The industrial range is dominated by hard and functional elements. Raw metal parts are turned into luminaires and spread the rough style of factory halls. The Industrial Look celebrates the aesthetic of things imperfect.

Weiche Linien, verspielte Rundungen und Gemütlichkeit? Mitnichten. Im Industrial Sortiment dominieren harte und funktionelle Elemente. Rohe Metallteile werden zu Leuchten verarbeitet und verbreiten den groben Stil von Fabrikhallen. Der Industrial Look zelebriert die Ästhetik des Imperfekten.

Des lignes tendres, des arrondis enjoués et de la convivialité ? En aucun cas. Des éléments durs et fonctionnels dominent la gamme industrielle. Des pièces métalliques brutes sont usinées pour devenir des luminaires et diffusent le style franc d'usines. Le look industriel symbolise l'esthétique de l'imperfection.

MILLIGAN 6	PONTEFRACT 9	MANBY 10-11	RINROE 12-13	ROUNDHAM 14	DELLOW 16-17	NOHALES 19	REDCLIFFE 20
CATTERICK 22	IKESTON 24-25	SPEKE 26	SEDBERGH 27	TAKELEY 28	BARNSTAPLE 1 30-31	SHIREBROOK 31	BARNSTAPLE 32-35
LUBENHAM 1 36	LUBENHAM 36-37	WINKWORTH 1 38	EBURY 39	TRURO 1 40	TRURO 2 40, 42	GRANTHAM 1 40	AUCKLAND 42
PRIDDY 1 42	PRIDDY 45-46	TREBURY 48	COVALEDA 48	MARDYKE 50-51	EMBLETON 51	LONGINO 52	TOOTHILL 53
CHARTERHOUSE 54	ELSWICK 56	FEMBARD 56	WILMCOTE 56	OLDBURY 58	TOWNSHEND 4 59-61	PRESTWICK 2 62-63	PRESTWICK 63
GATEBECK 64	MACCLES 66-67	CAWTON 68-69	LAYHAM 70	HARBOROUGH 72	EVESHAM 72-73	KILNSDALE 74	



This product is available in different colors and shapes./ Dieser Artikel ist in unterschiedlichen Farben und Formen verfügbar.
Cet article est disponible en différentes couleurs et formes.



43626

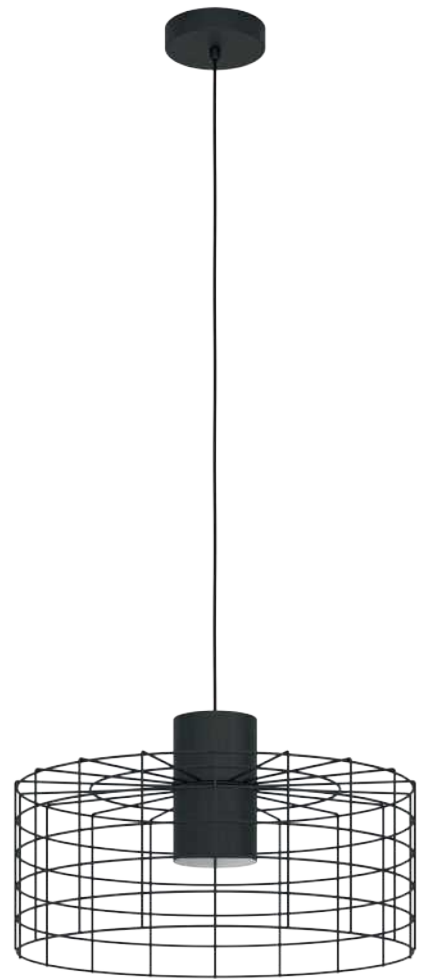

43628

43626 MILLIGAN

pendant light; steel, black, white
 Hängeleuchte; Stahl, schwarz, weiss
 luminaire en suspension; acier, noir, blanc

L 1030, B 200, H 1100



E27 3x 40W



9 002759 436261

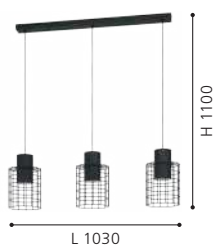

43628 MILLIGAN

pendant light; steel, black, white
 Hängeleuchte; Stahl, schwarz, weiss
 luminaire en suspension; acier, noir, blanc

H 1100, Ø 480



E27 1x 40W



9 002759 436285

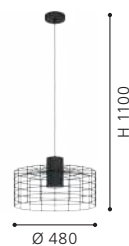

43627 MILLIGAN

pendant light; steel, black, white
 Hängeleuchte; Stahl, schwarz, weiss
 luminaire en suspension; acier, noir, blanc

H 1100, Ø 380



E27 1x 40W



9 002759 436278

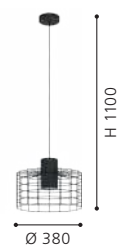



43627



43891

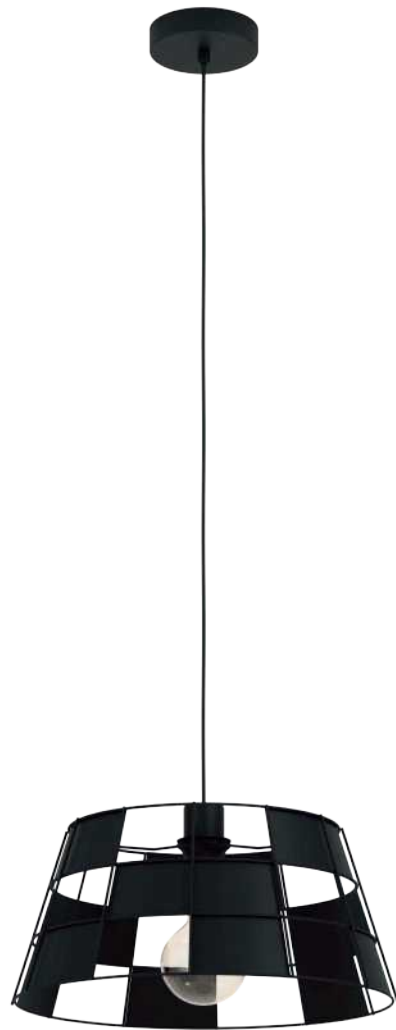

43892

DESIGN
HIGHLIGHT
DETAIL



43891 PONTEFRACT

ceiling light; steel, black
Deckenleuchte; Stahl, schwarz
plafonnier; acier, noir

H 205, Ø 420



E27



1x 40W



9 002759 438913



43892 PONTEFRACT

pendant light; steel, black
Hängeleuchte; Stahl, schwarz
luminaire en suspension; acier, noir

H 1100, Ø 420



E27



1x 40W



9 002759 438920





43796

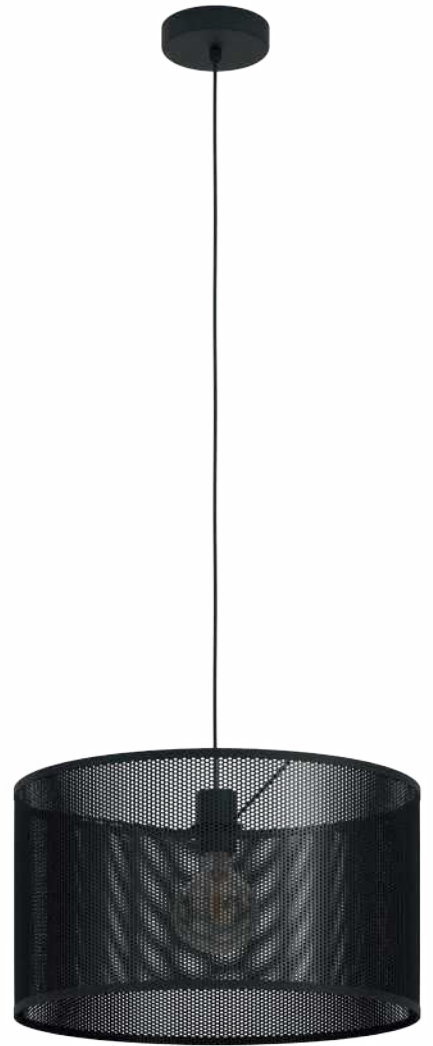

43795

43796 MANBY

pendant light; steel, black
 Hängeleuchte; Stahl, schwarz
 luminaire en suspension; acier, noir

L 900, B 200, H 1100



E27



3x 40W



9 002759 437961



43795 MANBY

pendant light; steel, black
 Hängeleuchte; Stahl, schwarz
 luminaire en suspension; acier, noir

H 1100, Ø 450



E27



1x 40W



9 002759 437954

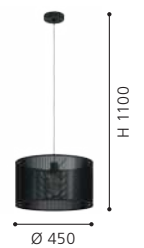



43794



43797

43794 MANBY

ceiling light; steel, black
Deckenleuchte; Stahl, schwarz
plafonnier; acier, noir

H 280, Ø 450



E27



1x 40W



9 002759 437947



43797 MANBY

table light; steel, black
Tischleuchte; Stahl, schwarz
luminaire de table; acier, noir

H 485, Ø 240, Base: Ø 230



E27



1x 40W



9 002759 437978





DESIGN
HIGHLIGHT
DETAIL



43966

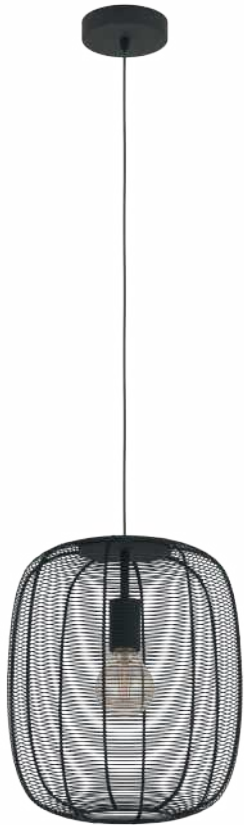

43965



43968

43965 RINROE

pendant light; steel, black
Hängeleuchte; Stahl, schwarz
luminaire en suspension; acier, noir

H 1100, Ø 325



E27 1x 40W



9 002759 439651



43966 RINROE

pendant light; steel, black
Hängeleuchte; Stahl, schwarz
luminaire en suspension; acier, noir

L 900, B 325, H 1100



E27 2x 40W



9 002759 439668



43968 RINROE

floor light; steel, black
Stehleuchte; Stahl, schwarz
lampadaire; acier, noir

H 1405, Ø 325, Base: Ø 630



E27 1x 40W



9 002759 439682

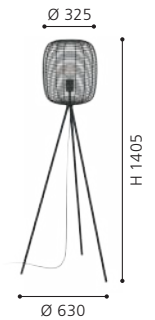



43967



43896

43967 RINROE

table light; steel, black
Tischleuchte; Stahl, schwarz
luminaire de table; acier, noir

H 440, Ø 200, Base: Ø 225



E27



1x 40W



9 002759 439675



43896 RINROE

ceiling light; steel, black
Deckenleuchte; Stahl, schwarz
plafonnier; acier, noir

H 200, Ø 450



E27



1x 40W



9 002759 438968



DESIGN
HIGHLIGHT
DETAIL

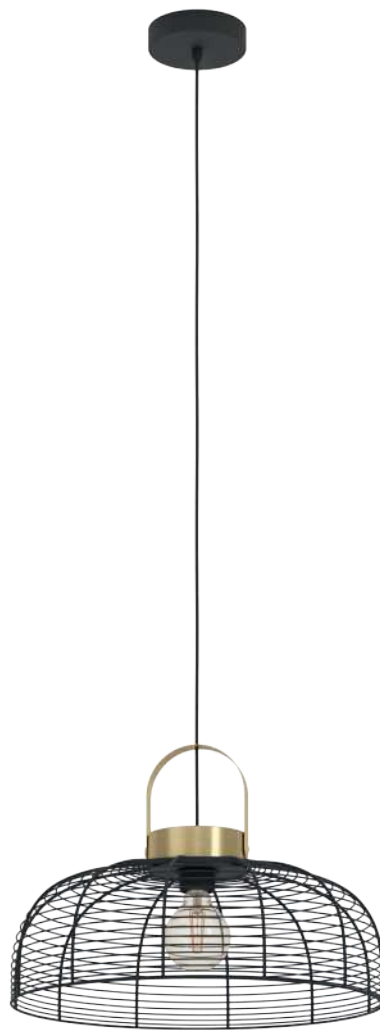

43964

43964 ROUNDHAM

pendant light; steel, black, brushed brass
Hängeleuchte; Stahl, schwarz, messing-gebürstet
luminaire en suspension; acier, noir, laiton brossé

H 1100, Ø 450



E27 1x 40W



9 002759 439644



43963 ROUNDHAM

pendant light; steel, black, brushed brass
Hängeleuchte; Stahl, schwarz, messing-gebürstet
luminaire en suspension; acier, noir, laiton brossé

H 1100, Ø 220



E27 1x 40W



9 002759 439637

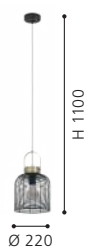



43963



43605



43603

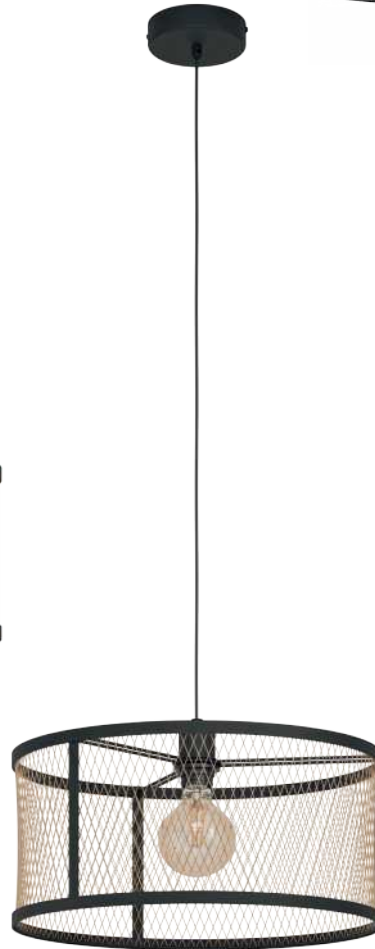

43604

43605 DELLOW

pendant light; steel, black / steel, black, brass
 Hängeleuchte; Stahl, schwarz / Stahl, schwarz, messing
 luminaire en suspension; acier, noir / acier, noir, laiton

L 880, B 180, H 1100



E27 3x 40W



9 002759 436056



43604 DELLOW

pendant light; steel, black / steel, black, brass
 Hängeleuchte; Stahl, schwarz / Stahl, schwarz, messing
 luminaire en suspension; acier, noir / acier, noir, laiton

H 1100, Ø 450



E27 1x 40W



9 002759 436049



43603 DELLOW

ceiling light; steel, black / steel, black, brass
 Deckenleuchte; Stahl, schwarz / Stahl, schwarz, messing
 plafonnier; acier, noir / acier, noir, laiton

H 270, Ø 450



E27 1x 40W



9 002759 436032





43533



43531



43532

43533 DELLOW

spot; steel, black / steel, black, brass
 Spot; Stahl, schwarz / Stahl, schwarz, messing
 spot; acier, noir / acier, noir, laiton

L 830, B 180, H 210



E27



3x 40W



9 002759 435332

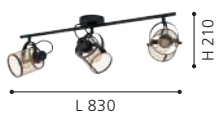

L 830

43532 DELLOW

spot; steel, black / steel, black, brass
 Spot; Stahl, schwarz / Stahl, schwarz, messing
 spot; acier, noir / acier, noir, laiton

L 475, B 180, H 210



E27



2x 40W



9 002759 435325



L 475

43531 DELLOW

spot; steel, black / steel, black, brass
 Spot; Stahl, schwarz / Stahl, schwarz, messing
 spot; acier, noir / acier, noir, laiton

L 180, B 110, H 200



E27



1x 40W



9 002759 435318

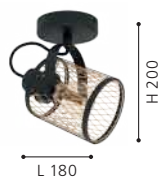

L 180

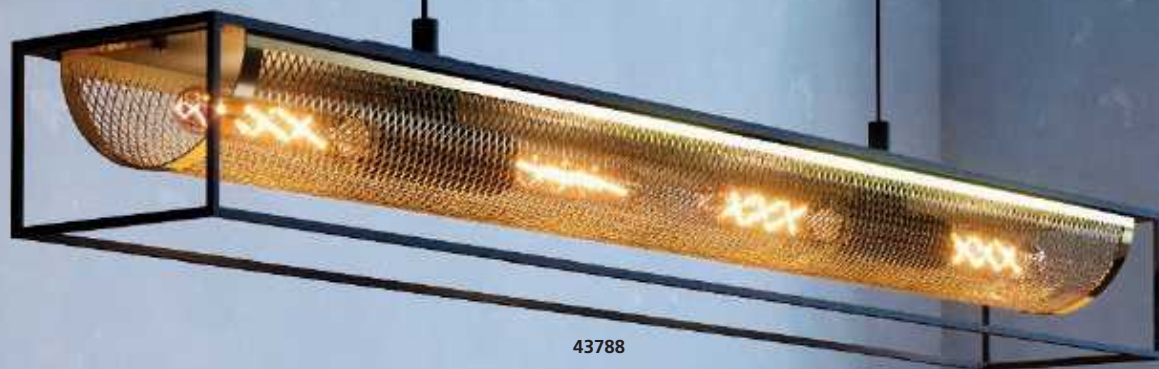

43788

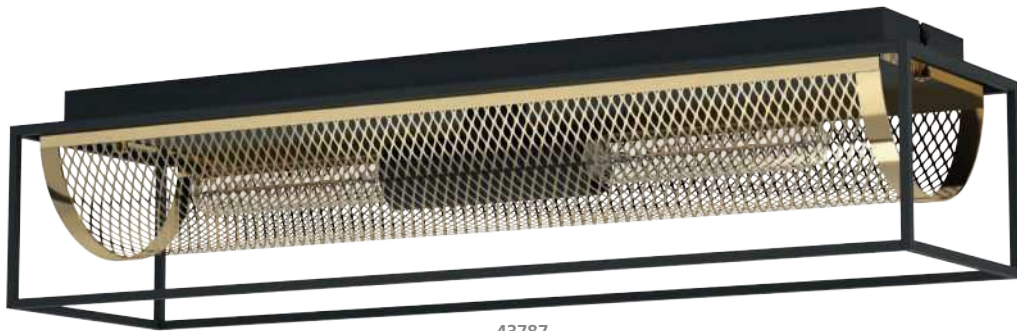

43787



43789



43788 NOHALES

pendant light; steel, black, brass
Hängeleuchte; Stahl, schwarz, messing
luminaire en suspension; acier, noir, laiton

L 1120, B 170, H 1500



E27



4x 40W



9 002759 437886

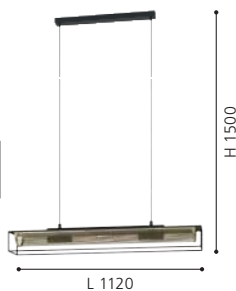

43789 NOHALES

wall light; steel, black, brass
Wandleuchte; Stahl, schwarz, messing
Applique; acier, noir, laiton

L 170, H 320, A 145



E27



1x 40W



9 002759 437893



43787 NOHALES

ceiling light; steel, black, brass
Deckenleuchte; Stahl, schwarz, messing
plafonnier; acier, noir, laiton

L 640, B 170, H 145



E27



2x 40W



9 002759 437879

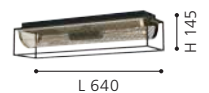



43534



43535

DETAIL 43534

To replace the bulbs, the two halves of the luminaires can be taken apart in the middle.

Zum Tausch der Leuchtmittel können die beiden Hälften der Leuchten in der Mitte auseinander genommen werden.

Pour remplacer les ampoules, les deux moitiés des luminaires peuvent être séparées au milieu.



43534 REDCLIFFE

pendant light; steel, black
Hängeleuchte; Stahl, schwarz
luminaire en suspension; acier, noir

L 1080, B 125, H 1100



E27 4x 40W



9 002759 435349



43535 REDCLIFFE

wall/ceiling light; steel, black
Wand- / Deckenleuchte; Stahl, schwarz
Applique/Plafonnier; acier, noir

L 540, B 120, H 145



E27 2x 40W



9 002759 435356



43537 REDCLIFFE

floor light; steel, black
Stehleuchte; Stahl, schwarz
lampadaire; acier, noir

H 1355, Ø 120, Base: Ø 250



E27 4x 40W



9 002759 435370

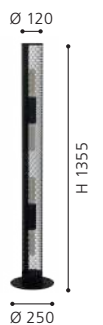



43537



43773



DESIGN
HIGHLIGHT
DETAIL

43773 CATTERICK

pendant light; steel, black
Hängeleuchte; Stahl, schwarz
luminaire en suspension; acier, noir

L 910, B 165, H 1100



E27



4x 40W



9 002759 437732



43772 CATTERICK

ceiling light; steel, black
Deckenleuchte; Stahl, schwarz
plafonnier; acier, noir

L 350, B 165, H 190



E27



2x 40W



9 002759 437725





43772





43728

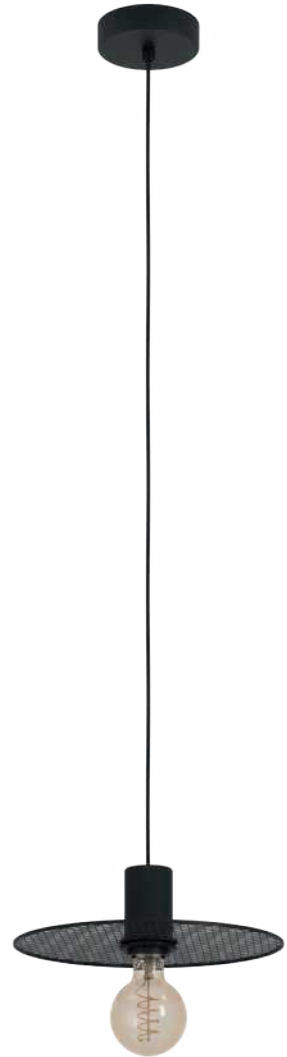

43731

43728 IKESTON

ceiling light; steel, black
Deckenleuchte; Stahl, schwarz
plafonnier; acier, noir

H 130, Ø 530



E27



3x 40W



9 002759 437282



43731 IKESTON

pendant light; steel, black
Hängeleuchte; Stahl, schwarz
luminaire en suspension; acier, noir

H 1100, Ø 280



E27



1x 40W



9 002759 437312

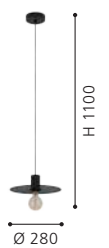



43729



43732

43732 IKESTON

pendant light; steel, black
Hängeleuchte; Stahl, schwarz
luminaire en suspension; acier, noir

L 980, B 280, H 1100



E27



4x 40W



9 002759 437329

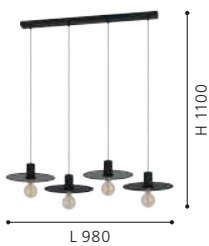

L 980

H 1100

43729 IKESTON

ceiling light; steel, black
Deckenleuchte; Stahl, schwarz
plafonnier; acier, noir

L 950, B 330, H 120



E27



4x 40W



9 002759 437299



L 950

H 120



43722 SPEKE

ceiling light; steel, black
Deckenleuchte; Stahl, schwarz
plafonnier; acier, noir

L 1560, B 310, H 105



E27



11x 40W



9 002759 437220

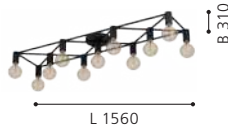

43721 SPEKE

ceiling light; steel, black
Deckenleuchte; Stahl, schwarz
plafonnier; acier, noir

L 415, B 310, H 105



E27



5x 40W



9 002759 437213

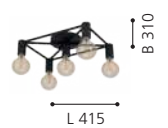

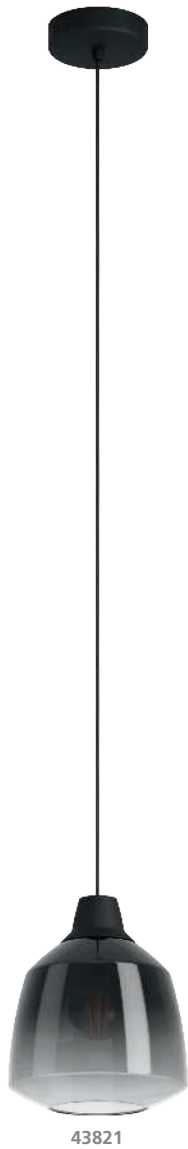

43821



43822

43821 SEDBERGH

pendant light; steel, black / glass, black-grey-transparent
 Hängeleuchte; Stahl, schwarz / Glas, schwarz-grau-transparent
 luminaire en suspension; acier, noir / verre, noir gris transparent

H 1100, Ø 200



E27



1x 40W



9 002759 438210



H 1100

Ø 200

43822 SEDBERGH

pendant light; steel, black / glass, black-grey-transparent
 Hängeleuchte; Stahl, schwarz / Glas, schwarz-grau-transparent
 luminaire en suspension; acier, noir / verre, noir-gris transparent

L 900, B 200, H 1100



E27



3x 40W



9 002759 438227



H 1100

L 900

DESIGN
HIGHLIGHT
DETAIL



DETAIL TAKELEY

The arms of the luminaires are individually adjustable.
Die Arme der Leuchten sind individuell einstellbar.
Les bras des luminaires sont réglables individuellement.



43562

43562 TAKELEY

ceiling light; steel, black
Deckenleuchte; Stahl, schwarz
plafonnier; acier, noir

B 1980, H 1325



E27



2x 28W



9 002759 435622

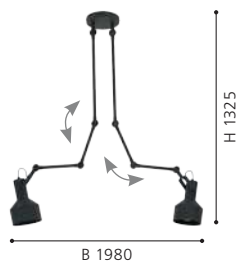

43561 TAKELEY

ceiling light; steel, black
Deckenleuchte; Stahl, schwarz
plafonnier; acier, noir

H 1325, Ø 150



E27



1x 28W



9 002759 435615





43561





43431



43432



43433

43431 BARNSTAPLE 1

spot; wood, steel, black / steel, black
 Spot; Holz, Stahl, schwarz / Stahl, schwarz
 spot; bois, acier, noir / acier, noir

L 160, B 160



9 002759 434311



L 160

43432 BARNSTAPLE 1

spot; wood, steel, black / steel, black
 Spot; Holz, Stahl, schwarz / Stahl, schwarz
 spot; bois, acier, noir / acier, noir

L 475, B 90



9 002759 434328



L 475

43433 BARNSTAPLE 1

spot; wood, steel, black / steel, black
 Spot; Holz, Stahl, schwarz / Stahl, schwarz
 spot; bois, acier, noir / acier, noir

L 750, B 90



9 002759 434335



L 750



43434



43726



43434 BARNSTAPLE 1

spot; wood, steel, black / steel, black
Spot; Holz, Stahl, schwarz / Stahl, schwarz
spot; bois, acier, noir / acier, noir

L 450, B 450



E27



4x 40W



9 002759 434342



L 450

43726 SHIREBROOK

pendant light; steel, wood, black
Hängeleuchte; Stahl, Holz, schwarz
luminaire en suspension; acier, bois, noir

L 1000, B 250, H 1100



E27



4x 40W



9 002759 437268



L 1000

H 1100



49648



49653



49652

49648 BARNSTAPLE

spot; wood, steel, brown-patina, black / steel, distressed zinc
 Spot; Holz, Stahl, braun-patina, schwarz / Stahl, used look
 Zink
 spot; bois, acier, marron patiné, noir / acier, look zinc usé

L 160, B 160



E27 1x 40W



9 002759 496487



49652 BARNSTAPLE

spot; wood, steel, brown-patina, black / steel, distressed zinc
 Spot; Holz, Stahl, braun-patina, schwarz / Stahl, used look
 Zink
 spot; bois, acier, marron patiné, noir / acier, look zinc usé

L 750, B 90



E27 3x 40W



9 002759 496524



49653 BARNSTAPLE

spot; wood, steel, brown-patina, black / steel, distressed zinc
 Spot; Holz, Stahl, braun-patina, schwarz / Stahl, used look
 Zink
 spot; bois, acier, marron patiné, noir / acier, look zinc usé

L 450, B 450



E27 4x 40W



9 002759 496531





49649

49649 BARNSTAPLE

spot; wood, steel, brown-patina, black / steel, distressed zinc
Spot; Holz, Stahl, braun-patina, schwarz / Stahl, used look
Zink
spot; bois, acier, marron patiné, noir / acier, look zinc usé

L 475, B 90



E27



2x 40W



9 002759 496494





49647



49722



49718

49647 BARNSTAPLE

pendant light; wood, steel, brown-patina, black / steel, distressed zinc

Hängeleuchte; Holz, Stahl, braun-patina, schwarz / Stahl, used look Zink

luminaire en suspension; bois, acier, marron patiné, noir / acier, look zinc usé

H 1500, Ø 270



E27 3x 40W



9 002759 496470



49722 BARNSTAPLE

floor light; wood, steel, brown-patina, black / steel, distressed zinc

Stehleuchte; Holz, Stahl, braun-patina, schwarz / Stahl, used look Zink

lampadaire; bois, acier, marron patiné, noir / acier, look zinc usé

H 1580, Base: Ø 270



E27 2x 40W



9 002759 497224

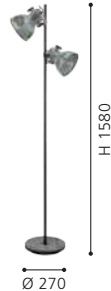

49718 BARNSTAPLE

table light; wood, steel, brown-patina, black / steel, distressed zinc

Tischleuchte; Holz, Stahl, braun-patina, schwarz / Stahl, used look Zink

luminaire de table; bois, acier, marron patiné, noir / acier, look zinc usé

B 175, H 400, Base: Ø 180



E27 1x 40W



9 002759 497187





49619

49619 BARNSTAPLE

pendant light; steel, black / steel, distressed zinc
Hängeleuchte; Stahl, schwarz / Stahl, used look Zink
luminaire en suspension; acier, noir / acier, look zinc usé

H 1100, Ø 175



E27



1x 40W



9 002759 496197

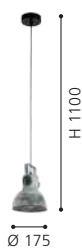

DESIGN
HIGHLIGHT
DETAIL





43168



44057



44056



43168 LUBENHAM 1

pendant light; steel, antique nickel, cream
 Hängeleuchte; Stahl, nickel-antik, creme
 luminaire en suspension; acier, nickel antique, crème

L 900, B 200, H 1100



E27 3x 28W



9 002759 431686

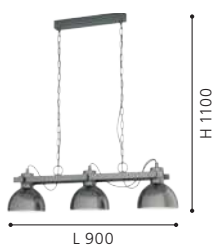

44056 LUBENHAM

pendant light; steel, wood, black, brown
 Hängeleuchte; Stahl, Holz, schwarz, braun
 luminaire en suspension; acier, bois, noir, marron

H 1100, Ø 300



E27 1x 28W



9 002759 440565



44057 LUBENHAM

wall light; steel, wood, black, brown
 Wandleuchte; Stahl, Holz, schwarz, braun
 Applique; acier, bois, noir, marron

L 175, H 205, A 210



E27 1x 28W



9 002759 440572





44058



44059



43992



44058 LUBENHAM

table light; steel, wood, black, brown
Tischleuchte; Stahl, Holz, schwarz, braun
luminaire de table; acier, bois, noir, marron

L 355, H 570, Base: Ø 180



E27 1x 28W



9 002759 440589



44059 LUBENHAM

floor light; steel, wood, black, brown
Stehleuchte; Stahl, Holz, schwarz, braun
lampadaire; acier, bois, noir, marron

L 475, B 300, H 1600, Base: Ø 300

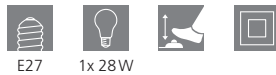

E27 1x 28W



9 002759 440596

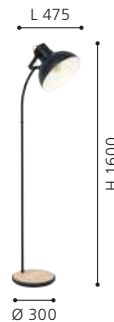

43992 LUBENHAM

pendant light; steel, wood, black, brown
Hängeleuchte; Stahl, Holz, schwarz, braun
luminaire en suspension; acier, bois, noir, marron

L 900, B 200, H 1100



E27 3x 28W



9 002759 439927

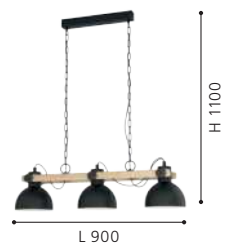

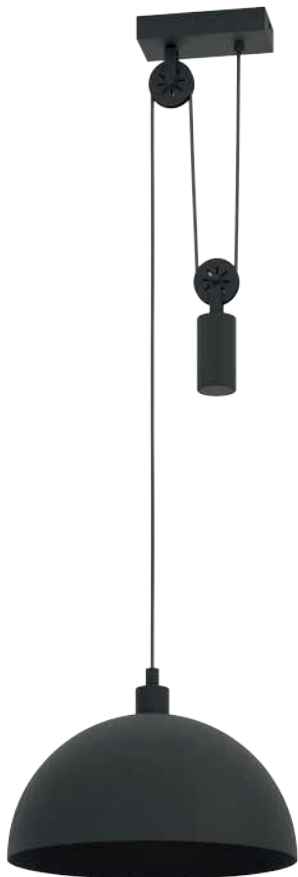

43435



43436



DETAIL WINKWORTH 1

The distance of the luminaires to the ceiling is individually adjustable due to the additional weight.

Der Abstand der Leuchten zur Decke ist durch das zusätzliche Gewicht individuell verstellbar.

La distance entre les luminaires et le plafond peut être réglée individuellement grâce au poids supplémentaire.

43435 WINKWORTH 1

pendant light; steel, black
Hängeleuchte; Stahl, schwarz
luminaire en suspension; acier, noir

H 910 - 1900, Ø 380



E27 1x 40W



9 002759 434359



43436 WINKWORTH 1

pendant light; steel, black
Hängeleuchte; Stahl, schwarz
luminaire en suspension; acier, noir

L 1180, B 380, H 910 - 1900



E27 2x 40W



9 002759 434366

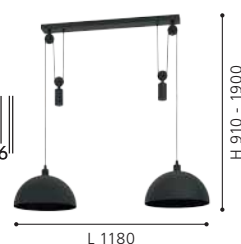



43621



43622

43621 Ebury

pendant light; steel, black, white
 Hängeleuchte; Stahl, schwarz, weiss
 luminaire en suspension; acier, noir, blanc

H 1100, Ø 380



E27



1x 60W



9 002759 436216



43622 Ebury

pendant light; steel, grey, white
 Hängeleuchte; Stahl, grau, weiss
 luminaire en suspension; acier, gris, blanc

H 1100, Ø 380



E27



1x 60W



9 002759 436223



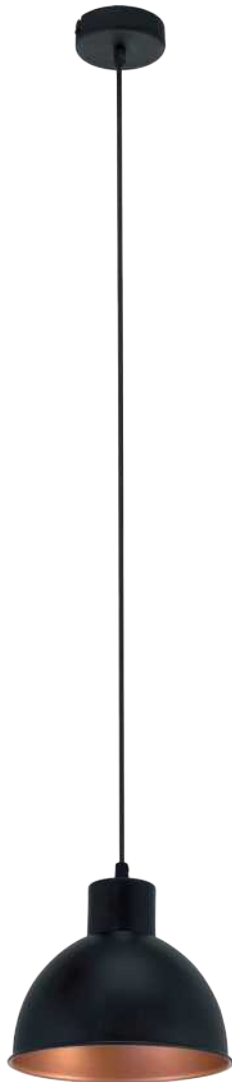

49238

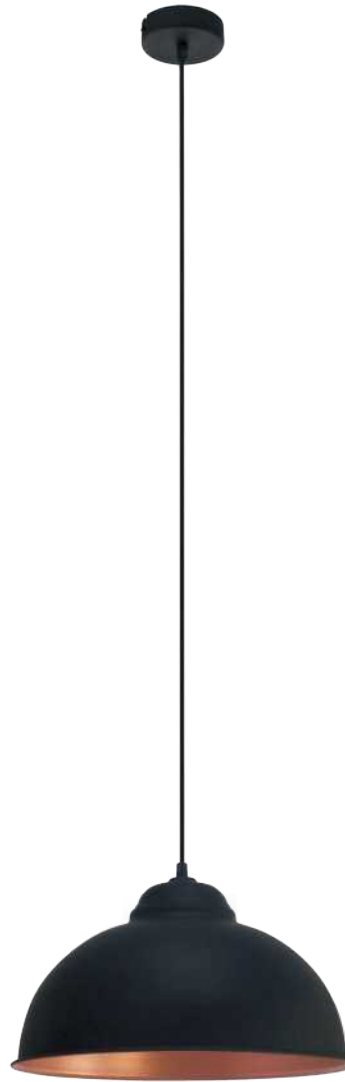

49247

49238 TRURO 1

pendant light; steel, black, copper
Hängeleuchte; Stahl, schwarz, kupfer
luminaire en suspension; acier, noir, cuivre

H 1100, Ø 210



E27 1x 60W



9 002759 492380

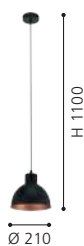

49247 TRURO 2

pendant light; steel, black, copper
Hängeleuchte; Stahl, schwarz, kupfer
luminaire en suspension; acier, noir, cuivre

H 1100, Ø 370



E27 1x 60W



9 002759 492472



49819 GRANTHAM 1

pendant light; steel, antique brown, beige
Hängeleuchte; Stahl, antik-braun, beige
luminaire en suspension; acier, marron antique, beige

H 1100, Ø 370



E27 1x 60W



9 002759 498191

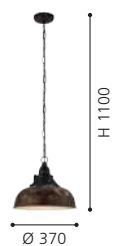



49819

DESIGN
HIGHLIGHT
DETAIL

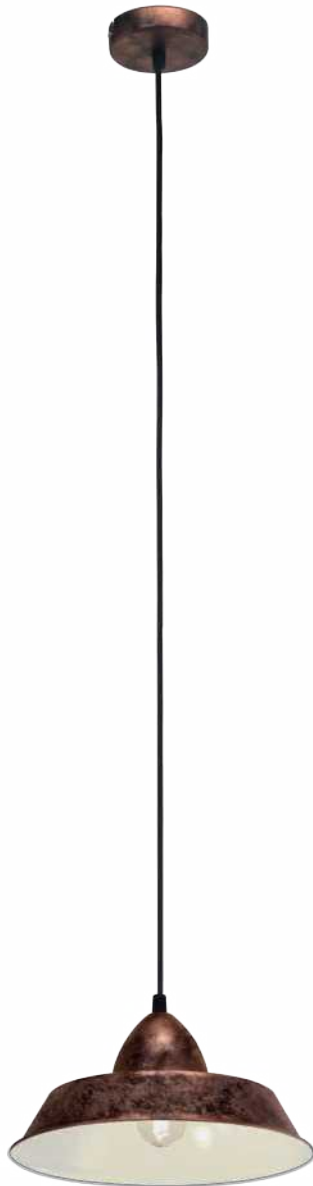

49243



49492

49243 AUCKLAND

pendant light; steel, antique copper coloured
Hängeleuchte; Stahl, kupferfarben-antik
luminaire en suspension; acier, cuivré antique

H 1100, Ø 260



E27 1x 60W



9 002759 492434



49492 PRIDDY 1

pendant light; steel, antique copper coloured
Hängeleuchte; Stahl, kupferfarben-antik
luminaire en suspension; acier, cuivré antique

H 1100, Ø 155



E27 1x 40W



9 002759 494926



49248 TRURO 2

pendant light; steel, antique copper coloured
Hängeleuchte; Stahl, kupferfarben-antik
luminaire en suspension; acier, cuivré antique

H 1100, Ø 370



E27 1x 60W



9 002759 492489





49248



43878





49464



49466

43878 PRIDDY

pendant light; steel, black, white
Hängeleuchte; Stahl, schwarz, weiss
luminaire en suspension; acier, noir, blanc

H 1100, Ø 305



E27



1x 40W



9 002759 438784



49464 PRIDDY

pendant light; steel, black, white
Hängeleuchte; Stahl, schwarz, weiss
luminaire en suspension; acier, noir, blanc

H 1100, Ø 155



E27



1x 40W



9 002759 494643

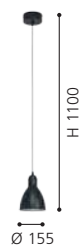

49466 PRIDDY

pendant light; steel, black, white
Hängeleuchte; Stahl, schwarz, weiss
luminaire en suspension; acier, noir, blanc

L 975, B 155, H 1100



E27



4x 40W



9 002759 494667





49468



49469

49468 PRIDDY

wall light; steel, black, white
Wandleuchte; Stahl, schwarz, weiss
Applique; acier, noir, blanc

L 130, H 215, A 200



E27 1x 40W



9 002759 494681



49469 PRIDDY

table light; steel, black, white
Tischleuchte; Stahl, schwarz, weiss
luminaire de table; acier, noir, blanc

H 425, Base: Ø 155



E27 1x 40W



9 002759 494698



49471 PRIDDY

floor light; steel, black, white
Stehleuchte; Stahl, schwarz, weiss
lampadaire; acier, noir, blanc

H 1370, Base: Ø 230

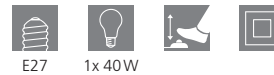

E27 1x 40W



9 002759 494711

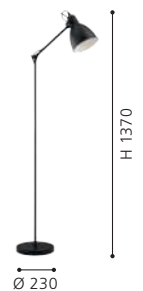



49471



DETAIL 43184

The luminaires can be individually extended by the movable and extendable arms.

Die Leuchten können durch die beweglichen und ausziehbaren Arme individuell verlängert werden.

Les luminaires peuvent être rallongés individuellement grâce aux bras mobiles et extensibles.



43184 TREBURLEY

wall light; steel, black, gold
Wandleuchte; Stahl, schwarz, gold
Applique; acier, noir, or

L 155, B 650, H 200



E27 1x 28W



9 002759 431846



49617 COVALEDA

table light; wood, steel, black, brass, gold
Tischleuchte; Holz, Stahl, schwarz, messing, gold
luminaire de table; bois, acier, noir, laiton, or

H 735, Ø 380



E27 1x 60W



9 002759 496173



49618 COVALEDA

floor light; wood, steel, black, brass, gold
Stehleuchte; Holz, Stahl, schwarz, messing, gold
lampadaire; bois, acier, noir, laiton, or

H 1640, Ø 550



E27 1x 60W



9 002759 496180

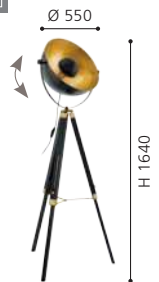



49618

49617



DETAIL MARDYKE

This luminaire series has a unique look with the mixture of steel and clear glass.

Diese Leuchtenserie verfügt mit der Mischung aus Stahl und Klarglas über eine einzigartige Optik.

Cette série de luminaires a un look unique avec le mélange d'acier et de verre transparent.

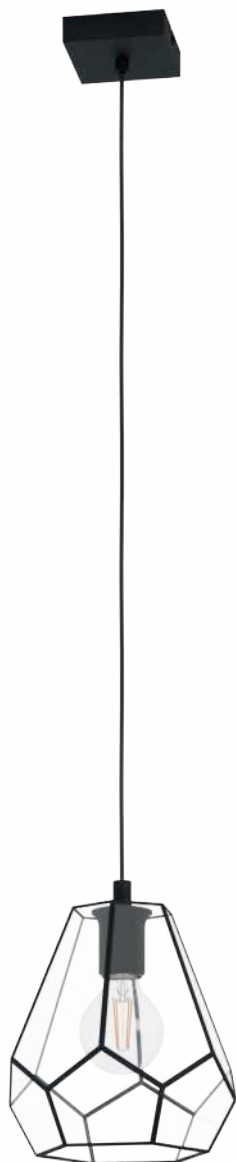

43643



43645



43646

43643 MARDYKE

pendant light; steel, black / glass, clear
Hängeleuchte; Stahl, schwarz / Glas, klar
luminaire en suspension; acier, noir / verre, transparent

H 1100, Ø 230



E27



1x 40W



9 002759 436438

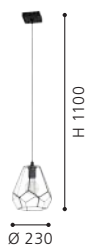

43645 MARDYKE

wall light; steel, black / glass, clear
Wandleuchte; Stahl, schwarz / Glas, klar
Applique; acier, noir / verre, transparent

L 145, H 205, A 195



E27



1x 40W



9 002759 436452

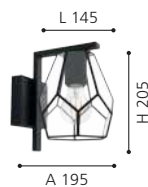

43646 MARDYKE

table light; steel, black / glass, clear
Tischleuchte; Stahl, schwarz / Glas, klar
luminaire de table; acier, noir / verre, transparent

L 190, B 150, H 505, Base: B 188, T 128



E27



1x 40W



9 002759 436469



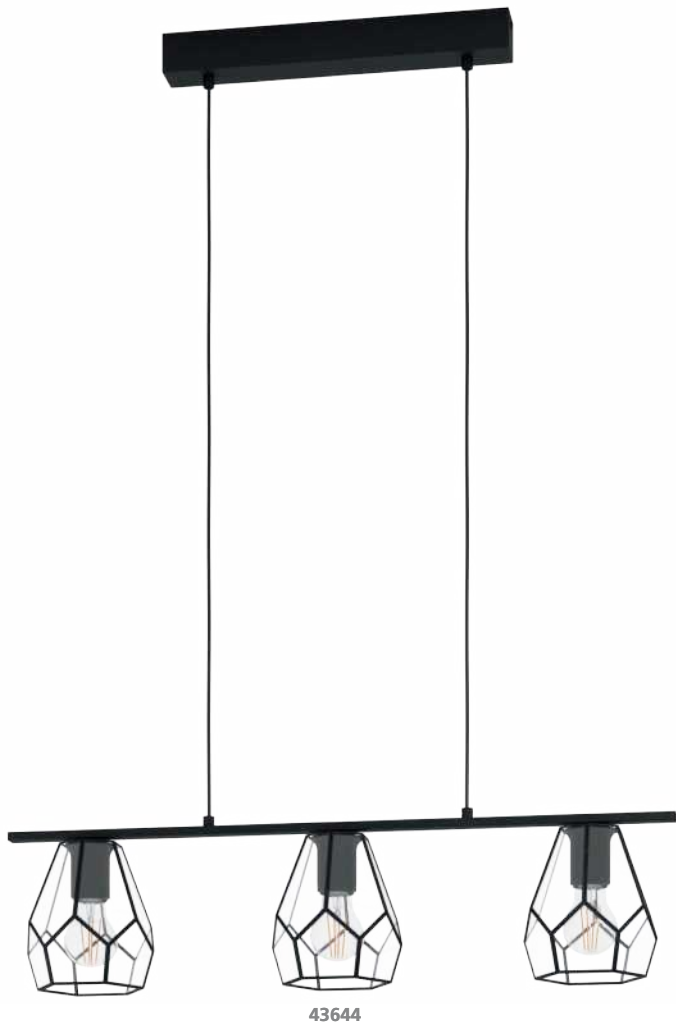

43644



49762

43644 MARDYKE

pendant light; steel, black / glass, clear
 Hängeleuchte; Stahl, schwarz / Glas, klar
 luminaire en suspension; acier, noir / verre, transparent

L 775, B 145, H 1100



E27

3x 40W



9 002759 436445

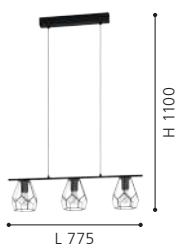

49762 EMBLETON

pendant light; steel, black
 Hängeleuchte; Stahl, schwarz
 luminaire en suspension; acier, noir

H 1500, Ø 460



E27

1x 60W



9 002759 497620

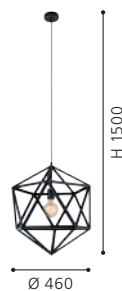

DESIGN
 HIGHLIGHT
 DETAIL



49495



49496

49495 LONCINO

pendant light; steel, black / smoked glass, black-transparent
 Hängeleuchte; Stahl, schwarz / Rauchglas, schwarz-transparent
 luminaire en suspension; acier, noir / verre fumé, noir transparent

L 150, B 150, H 1100



E27



1x 60W



9 002759 494957



49496 LONCINO

pendant light; steel, black / smoked glass, black-transparent
 Hängeleuchte; Stahl, schwarz / Rauchglas, schwarz-transparent
 luminaire en suspension; acier, noir / verre fumé, noir transparent

L 745, B 150, H 1100



E27



3x 60W



9 002759 494964





44003



44004

44003 TOOTHILL

wall light; steel, black / glass vaporized, black-transparent
 Wandleuchte; Stahl, schwarz / Glas bedampft, schwarz-transparent
 Applique; acier, noir / verre vaporisé, noir transparent

L 110, H 360, A 130



E27



1x 40W



9 002759 440039



44004 TOOTHILL

floor light; steel, black / glass vaporized, black-transparent
 Stehleuchte; Stahl, schwarz / Glas bedampft, schwarz-transparent
 lampadaire; acier, noir / verre vaporisé, noir transparent

H 1535, Ø 105, Base: Ø 195



E27



1x 40W



9 002759 440046





49392



49394

49392 CHARTERHOUSE

ceiling light; steel, black / glass, clear
Deckenleuchte; Stahl, schwarz / Glas, klar
plafonnier; acier, noir / verre, transparent

L 360, B 360, H 160



E27 2x 60W



9 002759 493929

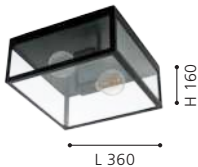

49394 CHARTERHOUSE

wall light; steel, black / glass, clear
Wandleuchte; Stahl, schwarz / Glas, klar
Applique; acier, noir / verre, transparent

L 160, H 280, A 150



E27 1x 60W



9 002759 493943



49393 CHARTERHOUSE

pendant light; steel, black / glass, clear
Hängeleuchte; Stahl, schwarz / Glas, klar
luminaire en suspension; acier, noir / verre, transparent

L 730, B 200, H 1100



E27 3x 60W



9 002759 493936





49393



49564



43365

49564 ELSWICK

pendant light; steel, black
Hängeleuchte; Stahl, schwarz
luminaire en suspension; acier, noir

L 1100, B 250, H 1500



E27 3x 60W



9 002759 495640



43365 FEMBAR

pendant light; steel, black
Hängeleuchte; Stahl, schwarz
luminaire en suspension; acier, noir

L 1005, B 40, H 1100



E27 7x 60W



9 002759 433659

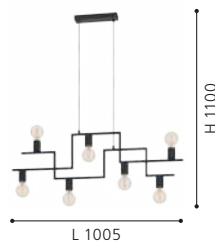

43126 WILMCOTE

ceiling light; steel, black
Deckenleuchte; Stahl, schwarz
plafonnier; acier, noir

H 380, Ø 280



E27 3x 60W



9 002759 431266





43126



44085



FSC



44086



FSC

44085 OLDBURY

pendant light; steel, wood, black, brown rustic
 Hängeleuchte; Stahl, Holz, schwarz, braun rustikal
 luminaire en suspension; acier, bois, noir, marron rustique

L 860, B 260, H 1100



E27



2x 60W



9 002759 440855



L 860

H 1100

44086 OLDBURY

pendant light; steel, wood, black, brown rustic
 Hängeleuchte; Stahl, Holz, schwarz, braun rustikal
 luminaire en suspension; acier, bois, noir, marron rustique

L 1180, B 260, H 1100



E27



3x 60W



9 002759 440862



L 1180

H 1100



43522

DESIGN
HIGHLIGHT
DETAIL



43152

43522 TOWNSHEND 4

ceiling light; steel, antique brown
Deckenleuchte; Stahl, antik-braun
plafonnier; acier, marron antique

L 550, B 140, H 260



E27



3x 60W



9 002759 435226

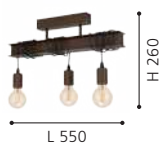

43152 TOWNSHEND 4

wall light; steel, black, brown
Wandleuchte; Stahl, schwarz, braun
Applique; acier, noir, marron

L 80, H 190, A 185



E27



1x 10W



9 002759 431525



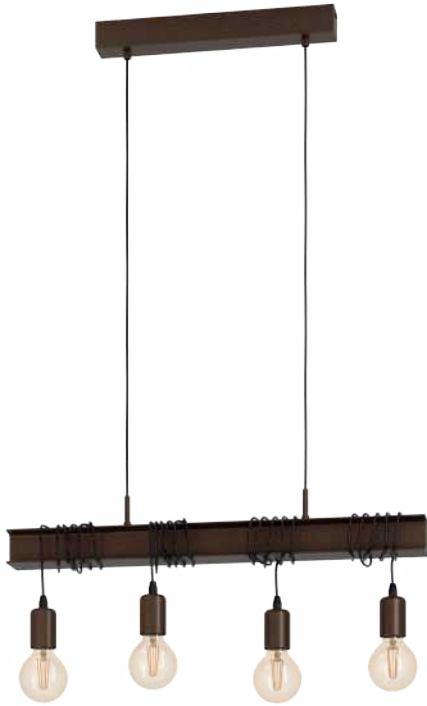

43523



43524

DETAIL TOWNSHEND 4

Thanks to the long cable of the luminaire heads the height can be adjusted individually.

Durch das lange Kabel der Leuchtenköpfe kann die Höhe individuell eingestellt werden.

Grâce au long câble des têtes de luminaire la hauteur peut être réglée individuellement.



43523 TOWNSHEND 4

pendant light; steel, antique brown, black
Hängeleuchte; Stahl, antik-braun, schwarz
luminaire en suspension; acier, marron antique, noir

L 700, B 140, H 1100



E27



4x 60W



9 002759 435233



43524 TOWNSHEND 4

pendant light; steel, antique brown, black
Hängeleuchte; Stahl, antik-braun, schwarz
luminaire en suspension; acier, marron antique, noir

L 1500, B 140, H 1100



E27



8x 60W



9 002759 435240

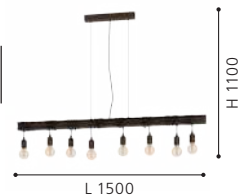



49859



43526



43525

49859 TOWNSHEND 4

pendant light; steel, antique brown, black
 Hängeleuchte; Stahl, antik-braun, schwarz
 luminaire en suspension; acier, marron antique, noir

L 1005, B 70, H 1100



E27



6x 60W



9 002759 498597

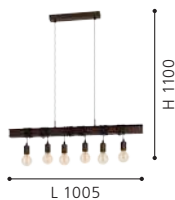

43526 TOWNSHEND 4

floor light; steel, antique brown, black
 Stehleuchte; Stahl, antik-braun, schwarz
 lampadaire; acier, marron antique, noir

L 260, B 250, H 1690, Base: Ø 250



E27



2x 10W



9 002759 435264



43525 TOWNSHEND 4

table light; steel, antique brown, black
 Tischleuchte; Stahl, antik-braun, schwarz
 luminaire de table; acier, marron antique, noir

L 165, B 155, H 500, Base: Ø 155



E27



1x 10W



9 002759 435257





43733



43733 PRESTWICK 2

table light; wood, brown
Tischleuchte; Holz, braun
luminaire de table; bois, marron

L 95, B 95, H 95



E27



1x 40W



9 002759 437336





43549



43734



49812

43549 PRESTWICK 2

table light; steel, dark bronze
Tischleuchte; Stahl, bronze dunkel
luminaire de table; acier, bronze foncé

L 100, B 100, H 100



E27 1x 40W



9 002759 435493



L 100

H 100

43734 PRESTWICK 2

table light; wood, black
Tischleuchte; Holz, schwarz
luminaire de table; bois, noir

L 95, B 95, H 95



E27 1x 40W



9 002759 437343



L 95

H 95

49812 PRESTWICK

table light; concrete, grey
Tischleuchte; Beton, grau
luminaire de table; béton, gris

L 90, B 90, H 130



E27 1x 60W



9 002759 498122



L 90

H 130



44091



44093



44091 GATEBECK

spot; wood, natural / steel, black
Spot; Holz, natur / Stahl, schwarz
spot; bois, naturel / acier, noir

L 110, B 110, H 205



E14



1x 40W



9 002759 440916

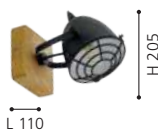

44093 GATEBECK

spot; wood, natural / steel, black
Spot; Holz, natur / Stahl, schwarz
spot; bois, naturel / acier, noir

L 590, B 110, H 205



E14



3x 40W



9 002759 440930



44092 GATEBECK

spot; wood, natural / steel, black
Spot; Holz, natur / Stahl, schwarz
spot; bois, naturel / acier, noir

L 360, B 110, H 205



E14



2x 40W



9 002759 440923

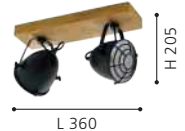



44092





43956



43956 MACCLES

pendant light; steel, wood, black, brown
Hängeleuchte; Stahl, Holz, schwarz, braun
luminaire en suspension; acier, bois, noir, marron

L 780, B 180, H 1100



E27



3x 15W



9 002759 439569





43955



43958



43959



43955 MACCLES

ceiling light; steel, wood, black, brown
Deckenleuchte; Stahl, Holz, schwarz, braun
plafonnier; acier, bois, noir, marron

L 780, B 180, H 205



E27



3x 15W



9 002759 439552



L 780

H 205

43958 MACCLES

wall light; steel, wood, black, brown
Wandleuchte; Stahl, Holz, schwarz, braun
Applique; acier, bois, noir, marron

L 180, H 150, A 200



E27



1x 15W



9 002759 439583

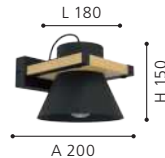

L 180

H 150

A 200

43959 MACCLES

table light; steel, wood, black, brown
Tischleuchte; Stahl, Holz, schwarz, braun
luminaire de table; acier, bois, noir, marron

H 150, Ø 180, Base: B 160, T 160



E27



1x 15W



9 002759 439590

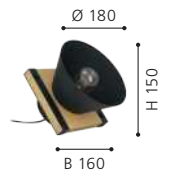

Ø 180

H 150

B 160



43953



43948



43949



43953 CAWTON

table light; steel, wood, steel coloured, rustic brown
Tischleuchte; Stahl, Holz, stahlfarben, braun rustikal
luminaire de table; acier, bois, couleur acier, marron rustique

L 240, B 160, H 380, Base: Ø 180



E27 1x 40W



9 002759 439538



43948 CAWTON

spot; steel, wood, steel coloured, rustic brown
Spot; Stahl, Holz, stahlfarben, braun rustikal
spot; acier, bois, couleur acier, marron rustique

L 160, H 195, A 300



E27 1x 40W



9 002759 439484



43949 CAWTON

spot; steel, wood, steel coloured, rustic brown
Spot; Stahl, Holz, stahlfarben, braun rustikal
spot; acier, bois, couleur acier, marron rustique

L 585, B 160, H 250



E27 2x 40W



9 002759 439491



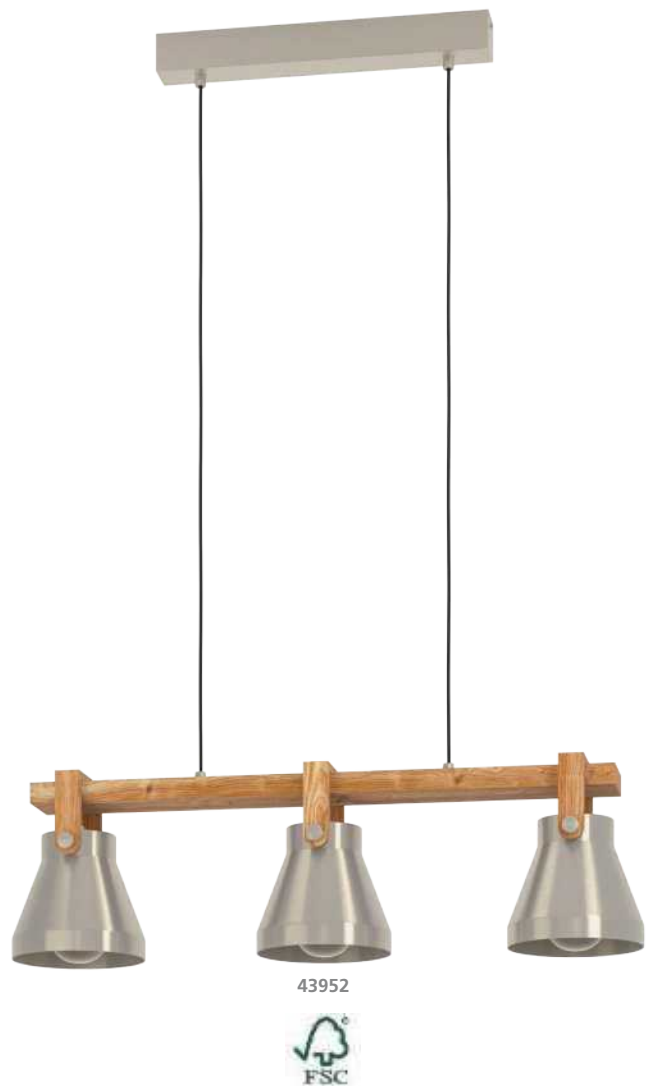

43954 CAWTON

floor light; steel, wood, steel coloured, rustic brown
 Stehleuchte; Stahl, Holz, stahlfarben, braun rustikal
 lampadaire; acier, bois, couleur acier, marron rustique

L 290, B 160, H 1345, Base: Ø 230



L 290



H 1345

Ø 230



9 002759 439545

43951 CAWTON

pendant light; steel, wood, steel coloured, rustic brown
 Hängeleuchte; Stahl, Holz, stahlfarben, braun rustikal
 luminaire en suspension; acier, bois, couleur acier, marron rustique

H 1100, Ø 160



H 1100

Ø 160



9 002759 439514

43952 CAWTON

pendant light; steel, wood, steel coloured, rustic brown
 Hängeleuchte; Stahl, Holz, stahlfarben, braun rustikal
 luminaire en suspension; acier, bois, couleur acier, marron rustique

L 760, B 160, H 1100



H 1100

L 760



9 002759 439521

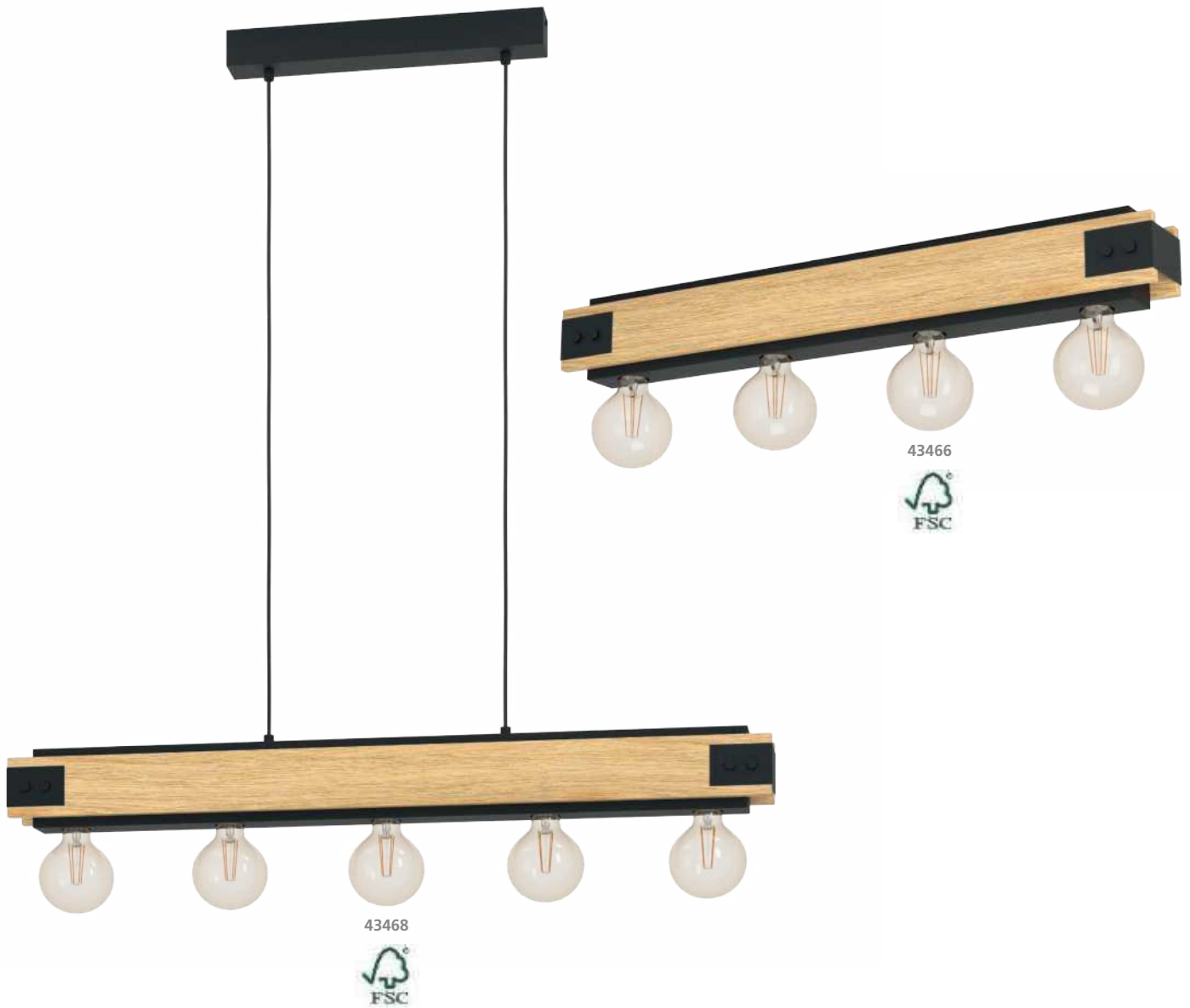

43468 LAYHAM

pendant light; wood, steel, brown, black
 Hängeleuchte; Holz, Stahl, braun, schwarz
 luminaire en suspension; bois, acier, marron, noir

L 960, B 85, H 1100



E27 5x 60W



9 002759 434687

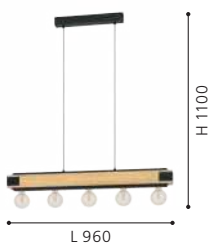

43466 LAYHAM

ceiling light; wood, steel, brown, black
 Deckenleuchte; Holz, Stahl, braun, schwarz
 plafonnier; bois, acier, marron, noir

L 760, B 85, H 100



E27 4x 60W



9 002759 434663

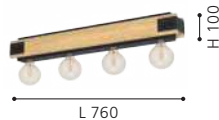

43469 LAYHAM

table light; wood, steel, brown, black
 Tischleuchte; Holz, Stahl, braun, schwarz
 luminaire de table; bois, acier, marron, noir

L 200, B 85, H 100



E27 1x 16W



9 002759 434694

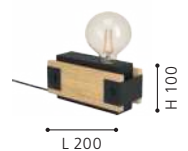



43469





43159



43805

43159 HARBOROUGH

pendant light; steel, black / wood, brown
 Hängeleuchte; Stahl, schwarz / Holz, braun
 luminaire en suspension; acier, noir / bois, marron

L 900, B 125, H 1100



E27



4x 40W



9 002759 431594

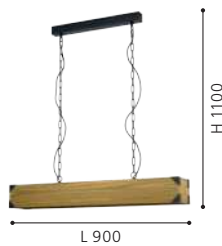

43805 EVESHAM

pendant light; steel, wood, black, brown
 Hängeleuchte; Stahl, Holz, schwarz, braun
 luminaire en suspension; acier, bois, noir, marron

L 895, B 195, H 1100



E27



3x 40W



9 002759 438050

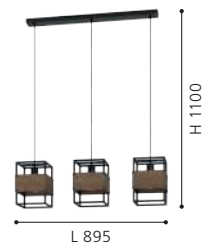



43804 EVESHAM

ceiling light; steel, wood, black, brown
 Deckenleuchte; Stahl, Holz, schwarz, braun
 plafonnier; acier, bois, noir, marron

L 875, B 195, H 250



E27 3x 40W



9 002759 438043



43807 EVESHAM

table light; steel, wood, black, brown
 Tischleuchte; Stahl, Holz, schwarz, braun
 luminaire de table; acier, bois, noir, marron

L 195, B 195, H 250



E27 1x 40W



9 002759 438074



43806 EVESHAM

wall light; steel, wood, black, brown
 Wandleuchte; Stahl, Holz, schwarz, braun
 Applique; acier, bois, noir, marron

L 140, H 240, A 170



E27 1x 40W



9 002759 438067





43832



43834

43832 KILNSDALE

ceiling light; steel, wood, black, brown
 Deckenleuchte; Stahl, Holz, schwarz, braun
 plafonnier; acier, bois, noir, marron

H 240, Ø 380



E27 1x 40W



9 002759 438326



43834 KILNSDALE

pendant light; steel, wood, black, brown
 Hängeleuchte; Stahl, Holz, schwarz, braun
 luminaire en suspension; acier, bois, noir, marron

L 810, B 110, H 1100



E27 3x 40W



9 002759 438340



43833 KILNSDALE

pendant light; steel, wood, black, brown
 Hängeleuchte; Stahl, Holz, schwarz, braun
 luminaire en suspension; acier, bois, noir, marron

H 1100, Ø 110



E27 1x 40W



9 002759 438333





43833



LOFT

#COSY
#CLEAR

Separate rooms and designated spaces for working, eating and leisure are a thing of the past. Free spirits need open spaces. The loft design imparts a sense of freedom and tranquillity, and the minimalist furnishings and accessories ensure your space still feels cosy and liveable. Simple yet sophisticated. Clean lines and dark surfaces offset by brighter accents are the main features of the loft aesthetic. Recreate this chic look in your own home with EGLO.

Die Zeiten in denen Wohnen, Essen und Arbeiten in getrennten Räumen stattfanden, sind vorbei. Freigeister brauchen Freiräume, um sich wohl zu fühlen. Der Loft-Look steht für Freiheit und Gelassenheit, welcher durch minimalistische Möbel und Accessoires trotzdem ein gemütliches Raumgefühl gibt. Einfach und doch raffiniert. Klare Linien, dunkle Oberflächen, kontrastiert von hellen Akzenten sind die Hauptmerkmale des Loft-Looks und mit EGLO holen Sie sich diesen Loft-Charm ganz einfach nach Hause.

Finie l'époque où l'on vivait, mangeait et travaillait dans des pièces distinctes ! Les esprits libres ont besoin d'espace pour se sentir bien. Le style loft est synonyme de liberté et de sérénité, mais donne néanmoins le sentiment d'un espace chaleureux grâce à un mobilier et à des accessoires minimalistes. Simple, mais sophistiqué. Des lignes épurées avec des surfaces foncées, contrastées par des touches claires, sont les principales caractéristiques du style loft. Appropriiez-vous son élégance dans votre intérieur avec EGLO.

HORNWOOD 2 78	BOYLE 80	HORNWOOD 82-83	LACEY 84-85	BRAMERTON 86-87	AYLES 87	CHIEVELEY 88-89	HALKIN 90
CONSETT 90-91	FAMBOROUGH 92-93	NAFFERTON 94-95	LITTLETON 96-97	BASILDON 1 98	BASILDON 98-99	CALLOW 100	SHERBURN 101
BUDDON 102	POCKLEY 102	BAILRIGG 102-103	TOWNSHEND 104-109	TOWNSHEND 5 110-113	PALMORLA 113	CARLTON 1 114-116,120-122	CARLTON 7 116-117
CARLTON 4 118	CARLTON 6 118	CARLTON 5 119	CARLTON-P 122	CARLTON 124-127	STYPE 128-129	STRAITON 130	VERNHAM 133
TARBES 134,146-151	CARLTON 2 134	STILLINGTON 136-137	STILLINGTON 1 138-139	SOUTHERY 140-141	LINTMILL 142	CASTANUELO 144-145	ROCCAMENA 152
CLEVEDON 153	NEWTOWN 154-155	AUSTELL 156	PLIMSOLL 159	WAVERTON 160-161	HORNWOOD 1 162	BIDFORD 163	LANTADA 163
CHESTER 164	CHESTER 1 164	CORETTO 2 165	HAPTON 165	COPLEY 166-167	WRINGTON 168-169	POMPEYA 171	WRINGTON 1 171
BAZELY 173	SALLICANO 173	TWICKEN 174-175	MATLOCK 176-179				

 This product is available in different colors and shapes./ Dieser Artikel ist in unterschiedlichen Farben und Formen verfügbar.
Cet article est disponible en différentes couleurs et formes.

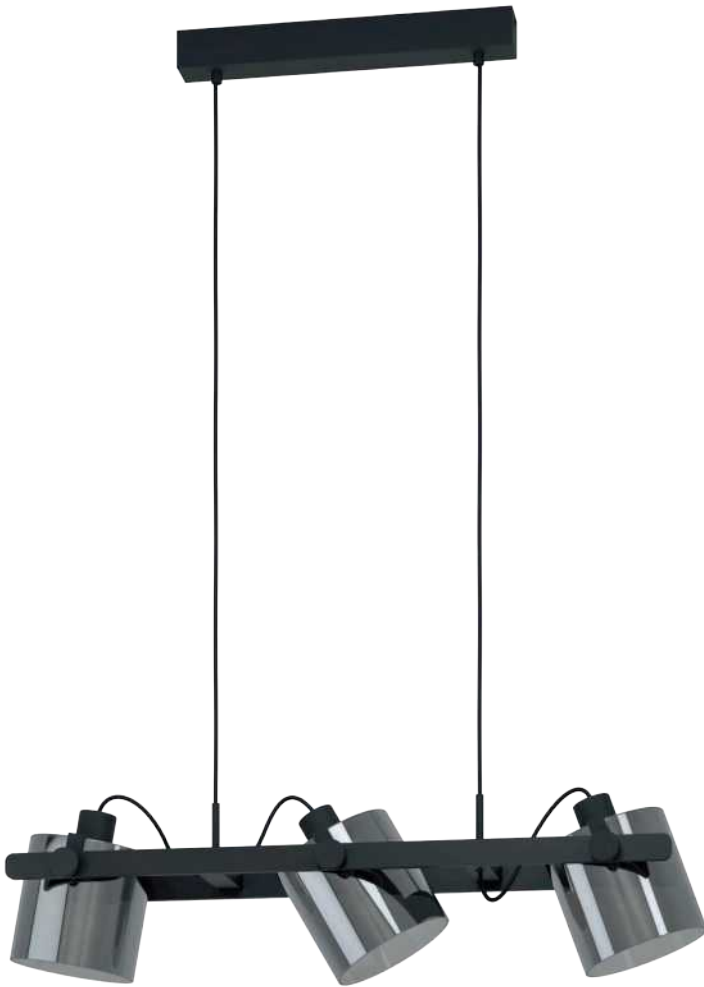

43606



DETAIL HORNWOOD 2

The heads of this luminaire can be swiveled individually.

Die Leuchtenköpfe sind individuell schwenkbar.

Les têtes de ce luminaire peuvent être pivotées individuellement.



DESIGN
HIGHLIGHT
DETAIL



43606 HORNWOOD 2

pendant light; steel, wood, black / glass vaporized, black-transparent

Hängeleuchte; Stahl, Holz, schwarz / Glas bedampft, schwarz-transparent

luminaire en suspension; acier, bois, noir / verre vaporisé, noir transparent

L 780, B 150, H 1100



E27



3x 40W



9 002759 436063

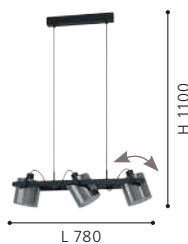

43671 HORNWOOD 2

ceiling light; steel, wood, black / glass vaporized, black-transparent

Deckenleuchte; Stahl, Holz, schwarz / Glas bedampft, schwarz-transparent

plafonnier; acier, bois, noir / verre vaporisé, noir transparent

L 1110, B 225, H 265



E27



4x 40W



9 002759 436711

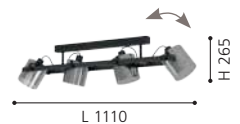



43671





43635



DESIGN
HIGHLIGHT
DETAIL

43635 BOYLE

ceiling light; steel, wood, black, brown / plastic, white
Deckenleuchte; Stahl, Holz, schwarz, braun / Kunststoff, weiss
plafonnier; acier, bois, noir, marron / plastique, blanc

L 780, B 170, H 300



E27



3x 10W



9 002759 436353



L 780

H 300

43636 BOYLE

pendant light; steel, wood, black, brown / plastic, white
Hängeleuchte; Stahl, Holz, schwarz, braun / Kunststoff, weiss
luminaire en suspension; acier, bois, noir, marron / plastique, blanc

L 780, B 170, H 1100



E27



3x 10W



9 002759 436360



L 780

H 1100



43636





43517



43424



DETAIL HORNWOOD

The heads can be adjusted or fixed in position with the lateral screws.

Die Köpfe können mittels den seitlichen Schrauben verstellt oder fixiert werden.

Les têtes peuvent être réglées ou fixées à l'aide des vis latérales.



43518



43517 HORNWOOD

pendant light; steel, black, creme / wood, brown
Hängeleuchte; Stahl, schwarz, creme / Holz, braun
luminaire en suspension; acier, noir, crème / bois, marron

L 780, B 210, H 1100



E27 3x 60W



9 002759 435172

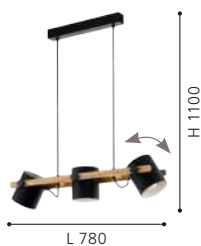

43424 HORNWOOD

pendant light; steel, black, creme / wood, brown
Hängeleuchte; Stahl, schwarz, creme / Holz, braun
luminaire en suspension; acier, noir, crème / bois, marron

L 1100, B 180, H 1100



E27 4x 28W



9 002759 434243

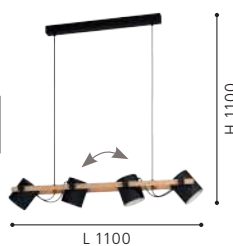

43518 HORNWOOD

wall light; steel, black, creme / wood, brown
Wandleuchte; Stahl, schwarz, creme / Holz, braun
applique; acier, noir, crème / bois, marron

Ø 170



E27 1x 28W



9 002759 435189





43558



43519



43521



43558 HORNWOOD

ceiling light; steel, black, creme / wood, brown
Deckenleuchte; Stahl, schwarz, creme / Holz, braun
plafonnier; acier, noir, crème / bois, marron

L 1000, B 190, H 275



E27



4x 28W



9 002759 435585

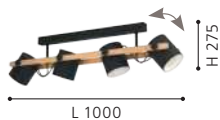

43519 HORNWOOD

table light; steel, black, creme / wood, brown
Tischleuchte; Stahl, schwarz, creme / Holz, braun
luminaire de table; acier, noir, crème / bois, marron

L 210, B 180, H 420, Base: Ø 180



E27



1x 28W



9 002759 435196



43521 HORNWOOD

floor light; steel, black, creme / wood, brown
Stehleuchte; Stahl, schwarz, creme / Holz, braun
lampadaire; acier, noir, crème / bois, marron

L 230, B 230, H 1400, Base: Ø 230



E27



1x 28W



9 002759 435219

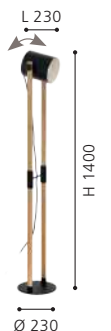



43735

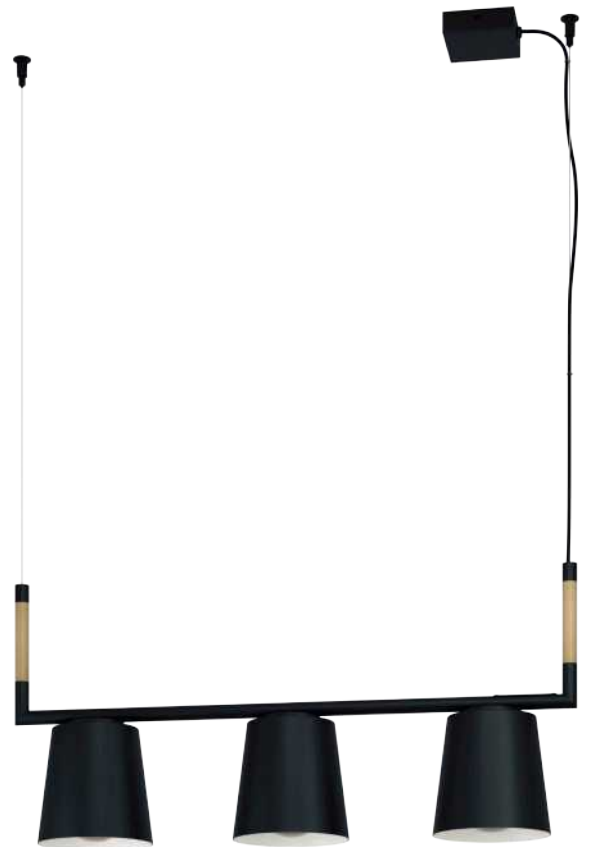

43612



LACEY

These luminaires have design elements made of real wood.

Diese Leuchten verfügen über Design-elemente aus Echtholz.

Ces luminaires disposent d'éléments de design en bois véritable.

43735 LACEY

wall light; steel, wood, black, brown / steel, black, creme
Wandleuchte; Stahl, Holz, schwarz, braun / Stahl, schwarz, creme

Applique; acier, bois, noir, marron / acier, noir, crème

L 135, H 275, A 265



E14



1x 40W



9 002759 437350



43612 LACEY

pendant light; steel, wood, black, brown / steel, black, creme
Hängeleuchte; Stahl, Holz, schwarz, braun / Stahl, schwarz, creme

luminaire en suspension; acier, bois, noir, marron / acier, noir, crème

L 780, B 160, H 1100



E27



3x 40W



9 002759 436124

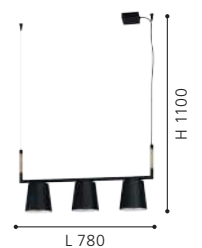



43611



43613



43614



43611 LACEY

ceiling light; steel, wood, black, brown / steel, black, creme
Deckenleuchte; Stahl, Holz, schwarz, braun / Stahl, schwarz, creme
plafonnier; acier, bois, noir, marron / acier, noir, crème

L 780, B 160, H 335



E27



3x 40W



9 002759 436117



L 780

H 335

43613 LACEY

table light; steel, wood, black, brown / steel, black, creme
Tischleuchte; Stahl, Holz, schwarz, braun / Stahl, schwarz, creme
luminaire de table; acier, bois, noir, marron / acier, noir, crème

L 255, B 135, H 485, Base: B 170, T 120



E14



1x 40W



9 002759 436131



L 255

H 485

B 170

43614 LACEY

floor light; steel, wood, black, brown / steel, black, creme
Stehleuchte; Stahl, Holz, schwarz, braun / Stahl, schwarz, creme
lampadaire; acier, bois, noir, marron / acier, noir, crème

L 310, B 160, H 1595, Base: B 280, T 200



E27



1x 40W



9 002759 436148

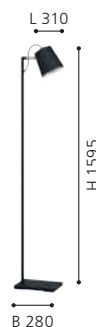

L 310

H 1595

B 280



43752 BRAMERTON

pendant light; steel, wood, black, brown
 Hängeleuchte; Stahl, Holz, schwarz, braun
 luminaire en suspension; acier, bois, noir, marron

L 810, B 120, H 1100

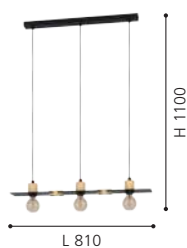

43751 BRAMERTON

ceiling light; steel, wood, black, brown
 Deckenleuchte; Stahl, Holz, schwarz, braun
 plafonnier; acier, bois, noir, marron

L 810, B 120, H 100

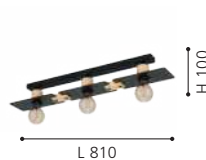

43753 BRAMERTON

wall light; steel, wood, black, brown
 Wandleuchte; Stahl, Holz, schwarz, braun
 Applique; acier, bois, noir, marron

L 120, H 110, A 215

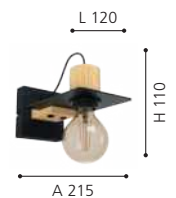



43749



43748



43754



43754 BRAMERTON

table light; steel, wood, black, brown
Tischleuchte; Stahl, Holz, schwarz, braun
luminaire de table; acier, bois, noir, marron

L 120, B 140, H 310, Base: B 120, T 140



E27



1x 40W



9 002759 437541



43749 AYLES

table light; steel, black / wood, brown
Tischleuchte; Stahl, schwarz / Holz, braun
luminaire de table; acier, noir / bois, marron

H 475, Base: Ø 260



GU10



1x 3W



1x
250lm



9 002759 437497



43748 AYLES

pendant light; steel, black / wood, brown
Hängeleuchte; Stahl, schwarz / Holz, braun
luminaire en suspension; acier, noir / bois, marron

L 930, B 85, H 1100



GU10



4x 3W



4x
250lm



9 002759 437480

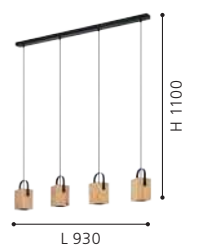



43541



DESIGN
HIGHLIGHT
DETAIL

43541 CHIEVELEY

pendant light; steel, black / wood, brown
Hängeleuchte; Stahl, schwarz / Holz, braun
luminaire en suspension; acier, noir / bois, marron

L 885, B 85, H 1100



E27



5x 40W

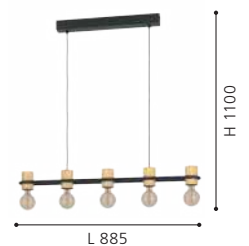



43542



43543

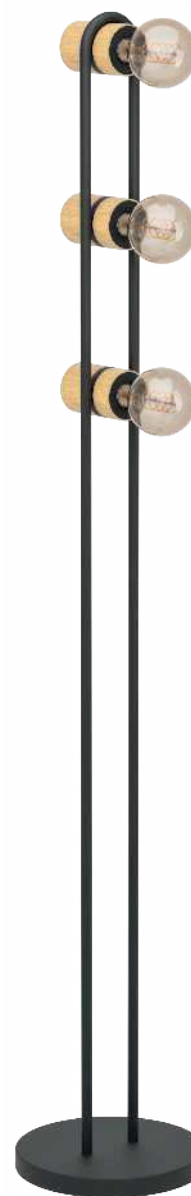

43544



43542 CHIEVELEY

wall light; steel, black / wood, brown
Wandleuchte; Stahl, schwarz / Holz, braun
Applique; acier, noir / bois, marron

L 285, H 90, A 115



E27 2x 40W



9 002759 435424

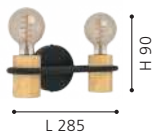

L 285

H 90

43543 CHIEVELEY

table light; steel, black / wood, brown
Tischleuchte; Stahl, schwarz / Holz, braun
luminaire de table; acier, noir / bois, marron

L 85, B 90, H 410, Base: Ø 155

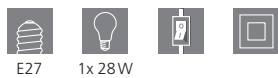

E27 1x 28W



9 002759 435431



L 85

H 410

Ø 155

43544 CHIEVELEY

floor light; steel, black / wood, brown
Stehleuchte; Stahl, schwarz / Holz, braun
lampadaire; acier, noir / bois, marron

L 85, B 90, H 1405, Base: Ø 230



E27 3x 28W



9 002759 435448



L 85

H 1405

Ø 230

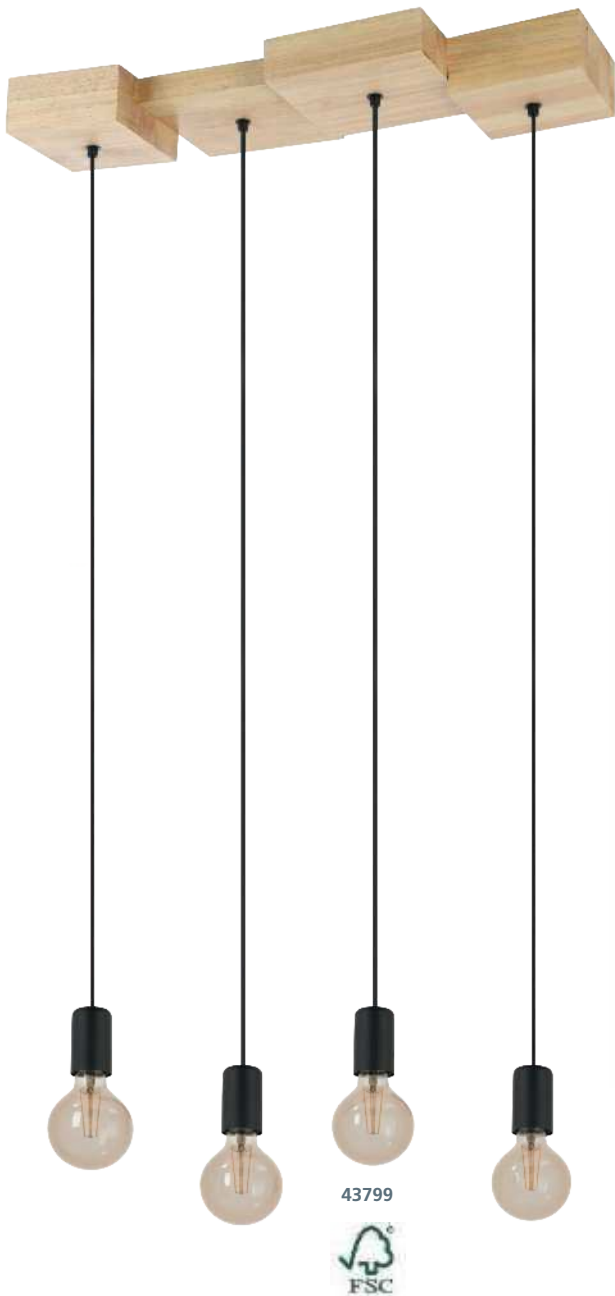

43799



43798



43724



43799 HALKIN

pendant light; wood, steel, brown, black
 Hängeleuchte; Holz, Stahl, braun, schwarz
 luminaire en suspension; bois, acier, marron, noir

L 720, B 250, H 1100



E27 4x 40W



9 002759 437992



43798 HALKIN

ceiling light; wood, steel, brown, black
 Deckenleuchte; Holz, Stahl, braun, schwarz
 plafonnier; bois, acier, marron, noir

L 400, B 430, H 140



E27 4x 40W



9 002759 437985

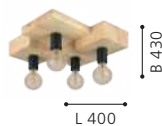

43724 CONSETT

ceiling light; steel, wood, black, brown
 Deckenleuchte; Stahl, Holz, schwarz, braun
 plafonnier; acier, bois, noir, marron

L 780, B 250, H 115



E27 6x 40W



9 002759 437244

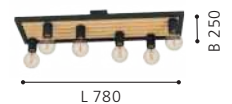



43725



43725 CONSETT

pendant light; steel, wood, black, brown
Hängeleuchte; Stahl, Holz, schwarz, braun
luminaire en suspension; acier, bois, noir, marron

L 780, B 250, H 1100



E27



6x 40W



9 002759 437251

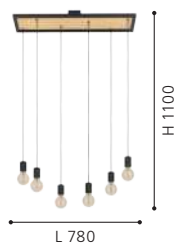

H 1100

L 780

DESIGN
HIGHLIGHT
DETAIL



43413



43413 FAMBOROUGH

pendant light; steel, wood, black, natural
Hängeleuchte; Stahl, Holz, schwarz, natur
luminaire en suspension; acier, bois, noir, naturel

L 160, B 105, H 1100



E27



1x 40W



9 002759 434137

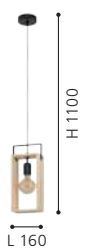



43414



43416



43415



43414 FAMBOROUGH

pendant light; steel, wood, black, natural
Hängeleuchte; Stahl, Holz, schwarz, natur
luminaire en suspension; acier, bois, noir, naturel

L 1000, B 160, H 1100



E27



5x 40W



9 002759 434144

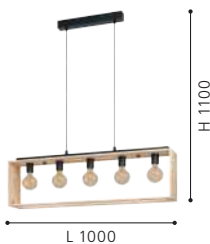

43416 FAMBOROUGH

table light; steel, wood, black, natural
Tischleuchte; Stahl, Holz, schwarz, natur
luminaire de table; acier, bois, noir, naturel

L 305, B 160, H 565, Base: B 300, T 160



E27



3x 40W



9 002759 434168



43415 FAMBOROUGH

table light; steel, wood, black, natural
Tischleuchte; Stahl, Holz, schwarz, natur
luminaire de table; acier, bois, noir, naturel

L 165, B 100, H 400, Base: B 160, T 100



E27



1x 40W



9 002759 434151





43744



43744 NAFFERTON

pendant light; steel, wood, black, brown
Hängeleuchte; Stahl, Holz, schwarz, braun
luminaire en suspension; acier, bois, noir, marron

L 800, B 100, H 1100



E27



3x 40W



9 002759 437442





43743



43746



43745



43743 NAFFERTON

pendant light; steel, wood, black, brown
Hängeleuchte; Stahl, Holz, schwarz, braun
luminaire en suspension; acier, bois, noir, marron

L 100, B 100, H 1100



E27



1x 40W



9 002759 437435

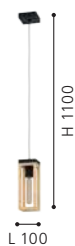

43746 NAFFERTON

table light; steel, wood, black, brown
Tischleuchte; Stahl, Holz, schwarz, braun
luminaire de table; acier, bois, noir, marron

L 100, B 100, H 280



E27



1x 40W



9 002759 437466



43745 NAFFERTON

wall light; steel, wood, black, brown
Wandleuchte; Stahl, Holz, schwarz, braun
Applique; acier, bois, noir, marron

L 100, H 280, A 125



E27



1x 40W



9 002759 437459

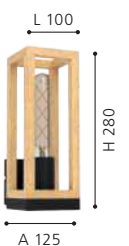

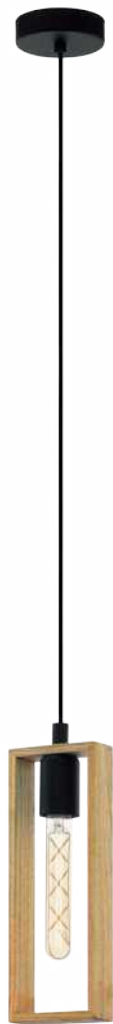

44051



44053



44051 LITTLETON

pendant light; steel, black / wood, brown
Hängeleuchte; Stahl, schwarz / Holz, braun
luminaire en suspension; acier, noir / bois, marron

L 110, B 100, H 1100



E27



1x 40W



9 002759 440510



44053 LITTLETON

pendant light; steel, black / wood, brown
Hängeleuchte; Stahl, schwarz / Holz, braun
luminaire en suspension; acier, noir / bois, marron

L 1160, B 55, H 1100



E27



4x 40W



9 002759 440534





44055



44054



44055 LITTLETON

wall light; steel, black / wood, brown
 Wandleuchte; Stahl, schwarz / Holz, braun
 Applique; acier, noir / bois, marron

L 110, H 330, A 115



E27



1x 40W



9 002759 440558

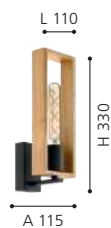

44054 LITTLETON

pendant light; steel, black / wood, brown
 Hängeleuchte; Stahl, schwarz / Holz, braun
 luminaire en suspension; acier, noir / bois, marron

H 1500, Ø 500



E27



6x 40W



9 002759 440541





DETAIL BASILDON

The black metal ring is individually adjustable.
Der schwarze Metallring ist individuell verstellbar.
L'anneau en métal noir est réglable individuellement.



43569



43461



43462



43569 BASILDON 1

table light; steel, wood, black, brown / fabric, black
Tischleuchte; Stahl, Holz, schwarz, braun / Textil, schwarz
luminaire de table; acier, bois, noir, marron / tissu, noir

H 425, Ø 230, Base: Ø 150



E27 1x 40W



9 002759 435691



43461 BASILDON

pendant light; steel, wood, black, brown
Hängeleuchte; Stahl, Holz, schwarz, braun
luminaire en suspension; acier, bois, noir, marron

L 190, B 160, H 1100



E27 1x 40W



9 002759 434618



43462 BASILDON

pendant light; steel, wood, black, brown
Hängeleuchte; Stahl, Holz, schwarz, braun
luminaire en suspension; acier, bois, noir, marron

L 780, B 160, H 1100



E27 3x 40W



9 002759 434625

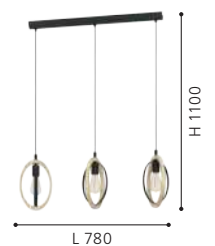



43736



43464



43463



43736 BASILDON

ceiling light; steel, wood, black, brown
Deckenleuchte; Stahl, Holz, schwarz, braun
plafonnier; acier, bois, noir, marron

H 375, Ø 320



E27



1x 40W



9 002759 437367

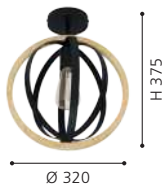

H 375

Ø 320

43464 BASILDON

table light; steel, wood, black, brown
Tischleuchte; Stahl, Holz, schwarz, braun
luminaire de table; acier, bois, noir, marron

L 190, B 160, H 345, Base: Ø 155



E27



1x 40W



9 002759 434649



L 190

H 345

Ø 155

43463 BASILDON

pendant light; steel, wood, black, brown
Hängeleuchte; Stahl, Holz, schwarz, braun
luminaire en suspension; acier, bois, noir, marron

H 1300, Ø 615



E27



3x 40W



9 002759 434632



H 1300

Ø 615



43756

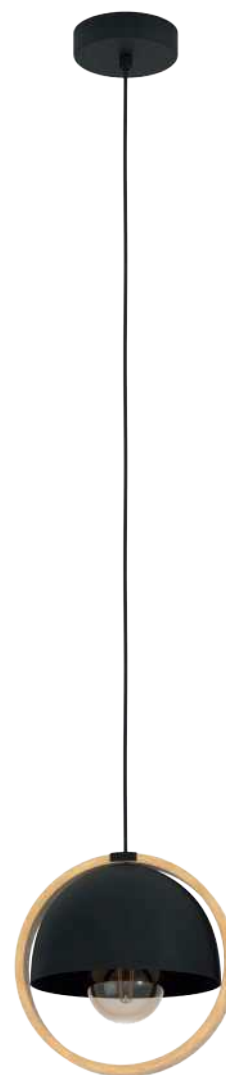

43755



43756 CALLOW

pendant light; steel, wood, black, brown
 Hängeleuchte; Stahl, Holz, schwarz, braun
 luminaire en suspension; acier, bois, noir, marron

L 930, B 230, H 1100



E27



3x 40W



9 002759 437565



43755 CALLOW

pendant light; steel, wood, black, brown
 Hängeleuchte; Stahl, Holz, schwarz, braun
 luminaire en suspension; acier, bois, noir, marron

H 1100, Ø 230



E27



1x 40W



9 002759 437558





43739



43738



43739 SHERBURN

pendant light; steel, wood, black, brown
 Hängeleuchte; Stahl, Holz, schwarz, braun
 luminaire en suspension; acier, bois, noir, marron

L 770, B 200, H 1100



E27



3x 40W



9 002759 437398



43738 SHERBURN

ceiling light; steel, wood, black, brown
 Deckenleuchte; Stahl, Holz, schwarz, braun
 plafonnier; acier, bois, noir, marron

L 800, B 200, H 255



E27



3x 40W



9 002759 437381



DETAIL 43898, 44013



These wall luminaires are easily adjustable using the cable wrap or the adjustable rod. No wall outlet is required for installation, just a socket below the luminaires.

Diese Wandleuchten sind einfach verstellbar mit Hilfe der Wickelung des Kabels bzw. des verstellbaren Stabes. Für die Montage ist kein Wandauslas notwendig, sondern nur eine Steckdose unterhalb der Leuchten.

Ces appliques sont facilement réglables à l'aide de l'enroulement du câble ou de la tige réglable. Pour le montage, il n'est pas nécessaire de prévoir une sortie murale, mais seulement une prise de courant sous le luminaire.



43898



44013



43904



43898 BUDDON

wall light; wood, steel, brown, black
Wandleuchte; Holz, Stahl, braun, schwarz
Applique; bois, acier, marron, noir

L 55, H 2600, A 80



E27 1x 13W



9 002759 438982

44013 POCKLEY

wall light; wood, steel, brown, black
Wandleuchte; Holz, Stahl, braun, schwarz
Applique; bois, acier, marron, noir

L 45, H 295, A 160



E27 1x 10W



9 002759 440138

43904 BAILRIGG

table light; steel, wood, black, brown
Tischleuchte; Stahl, Holz, schwarz, braun
luminaire de table; acier, bois, noir, marron

L 65, B 45, H 330, Base: B 130, T 80



E27 1x 40W



9 002759 439040



43901



43903

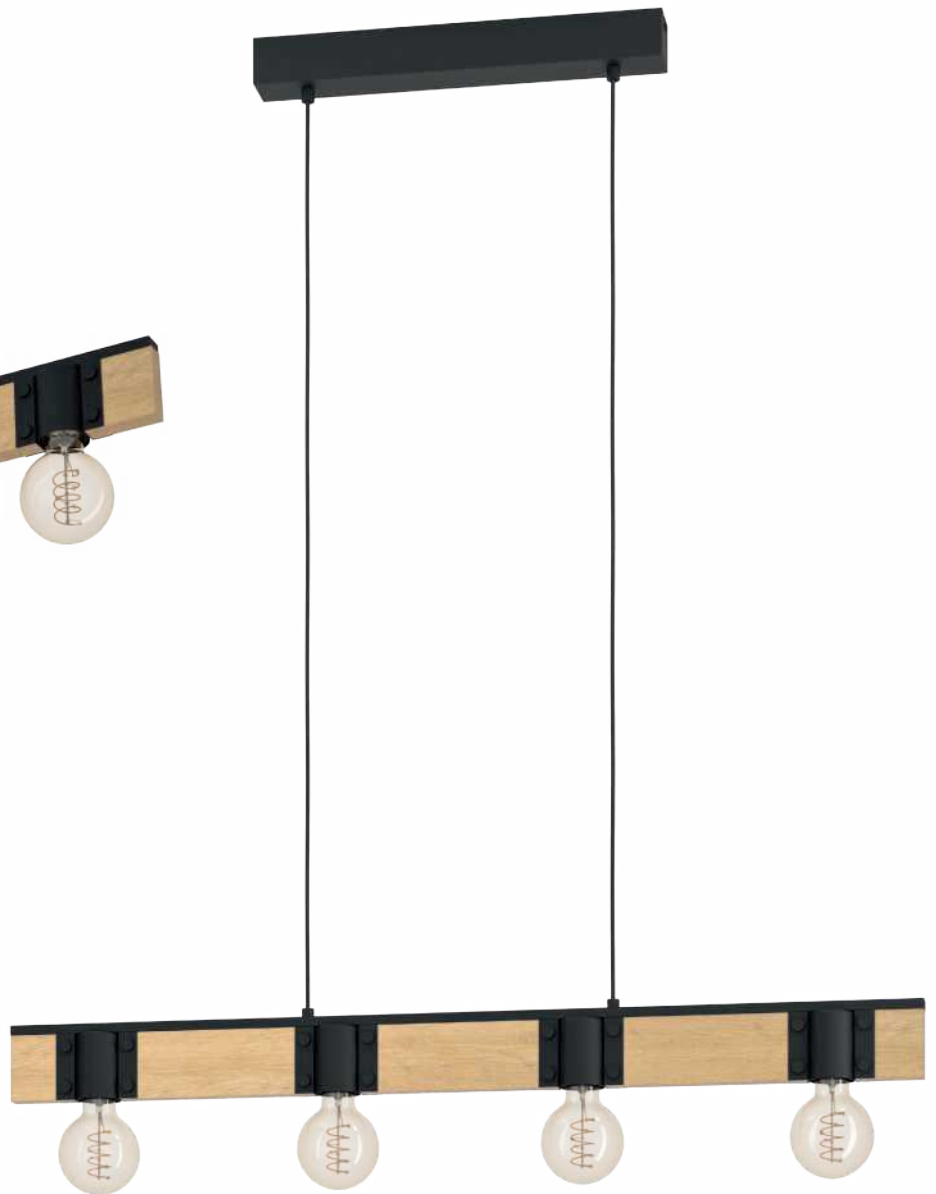

43902



43903 BAILRIGG

wall light; steel, wood, black, brown
Wandleuchte; Stahl, Holz, schwarz, braun
Applique; acier, bois, noir, marron

L 55, H 135, A 140



E27



1x 40W



9 002759 439033

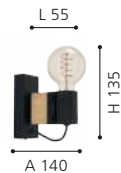

43901 BAILRIGG

ceiling light; steel, wood, black, brown
Deckenleuchte; Stahl, Holz, schwarz, braun
plafonnier; acier, bois, noir, marron

L 655, B 100, H 45



E27



3x 40W



9 002759 439019

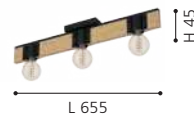

43902 BAILRIGG

pendant light; steel, wood, black, brown
Hängeleuchte; Stahl, Holz, schwarz, braun
luminaire en suspension; acier, bois, noir, marron

L 895, B 45, H 1100



E27



4x 40W



9 002759 439026

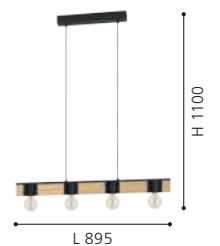



43704



43705



43704 TOWNSHEND

pendant light; steel, white / wood, brown
 Hängeleuchte; Stahl, weiss / Holz, braun
 luminaire en suspension; acier, blanc / bois, marron

L 700, B 105, H 1100



E27



4x 60W



9 002759 437046



43705 TOWNSHEND

pendant light; steel, white / wood, brown
 Hängeleuchte; Stahl, weiss / Holz, braun
 luminaire en suspension; acier, blanc / bois, marron

L 1000, B 100, H 1100



E27



6x 60W



9 002759 437053

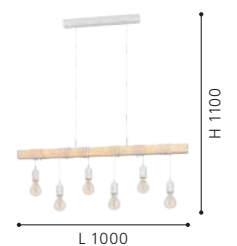



43706



44082



33163

43706 TOWNSHEND

wall light; steel, white / wood, brown
Wandleuchte; Stahl, weiss / Holz, braun
Applique; acier, blanc / bois, marron

L 65, H 215, A 185



E27



1x 10W



9 002759 437060



44082 TOWNSHEND

ceiling light; steel, white / wood, brown
Deckenleuchte; Stahl, weiss / Holz, braun
plafonnier; acier, blanc / bois, marron

L 550, B 105, H 265



E27



3x 60W



9 002759 440824

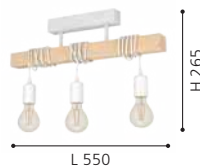

33163 TOWNSHEND

table light; steel, white / wood, brown
Tischleuchte; Stahl, weiss / Holz, braun
luminaire de table; acier, blanc / bois, marron

L 175, B 155, H 500, Base: Ø 155



E27



1x 10W



9 002759 331634

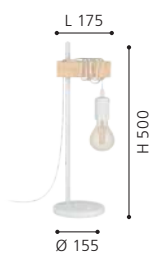



43513

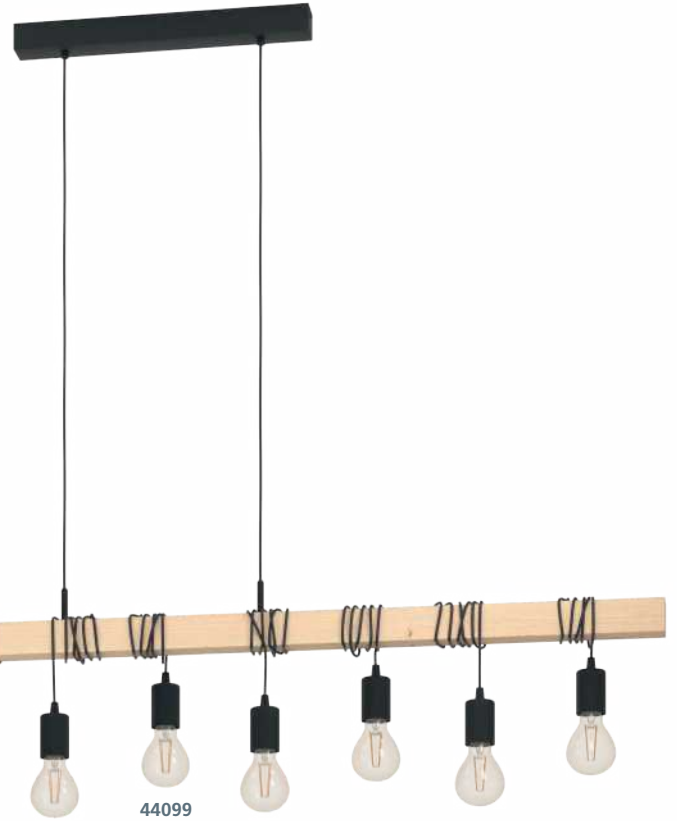

44099



DETAIL TOWNSHEND

Thanks to the long cable of the luminaire heads, the height can be adjusted individually.

Durch das lange Kabel der Leuchtenköpfe kann die Höhe individuell eingestellt werden.

Grâce au long câble des têtes de luminaire, la hauteur peut être réglée individuellement.



43513 TOWNSHEND

pendant light; steel, wood, black, brown
Hängeleuchte; Stahl, Holz, schwarz, braun
luminaire en suspension; acier, bois, noir, marron

L 1000, B 100, H 1100



E27



6x 60W



9 002759 435134

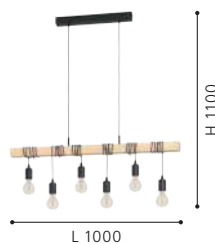

44099 TOWNSHEND

pendant light; wood, steel, brown, black
Hängeleuchte; Holz, Stahl, braun, schwarz
luminaire en suspension; bois, acier, marron, noir

L 1500, B 100, H 1100



E27



9x 60W



9 002759 440992

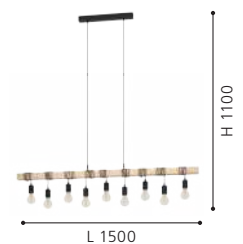

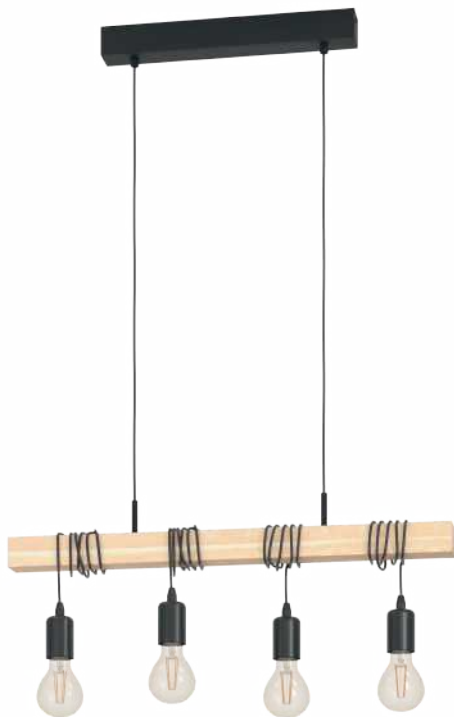

43512



43511



43512 TOWNSHEND

pendant light; steel, wood, black, brown
 Hängeleuchte; Stahl, Holz, schwarz, braun
 luminaire en suspension; acier, bois, noir, marron

L 700, B 105, H 1100



E27



4x 60W



9 002759 435127



43511 TOWNSHEND

ceiling light; steel, wood, black, brown
 Deckenleuchte; Stahl, Holz, schwarz, braun
 plafonnier; acier, bois, noir, marron

L 550, B 105, H 265



E27



3x 60W



9 002759 435110



DESIGN
HIGHLIGHT
DETAIL



43514 TOWNSHEND

wall light; steel, wood, black, brown
Wandleuchte; Stahl, Holz, schwarz, braun
Applique; acier, bois, noir, marron

L 65, H 215, A 190



E27 1x 10W



9 002759 435141



43515 TOWNSHEND

table light; steel, wood, black, brown
Tischleuchte; Stahl, Holz, schwarz, braun
luminaire de table; acier, bois, noir, marron

L 175, B 155, H 500, Base: Ø 155



E27 1x 10W



9 002759 435158



43516 TOWNSHEND

floor light; steel, wood, black, brown
Stehleuchte; Stahl, Holz, schwarz, braun
lampadaire; acier, bois, noir, marron

L 205, B 250, H 1665, Base: Ø 250

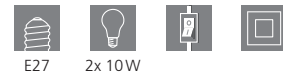

E27 2x 10W



9 002759 435165





44062



44062 TOWNSHEND

pendant light; steel, black / wood, black
Hängeleuchte; Stahl, schwarz / Holz, schwarz
luminaire en suspension; acier, noir / bois, noir

L 1000, B 100, H 1100



E27



6x 40W



9 002759 440626

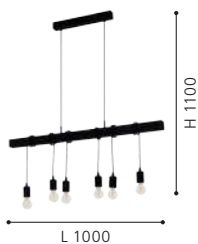



44074



44075



44074 TOWNSHEND 5

ceiling light; steel, wood, black, brown
Deckenleuchte; Stahl, Holz, schwarz, braun
plafonnier; acier, bois, noir, marron

L 550, B 200, H 360



E27



3x 60W



9 002759 440749



L 550

H 360

44075 TOWNSHEND 5

pendant light; steel, wood, black, brown
Hängeleuchte; Stahl, Holz, schwarz, braun
luminaire en suspension; acier, bois, noir, marron

L 700, B 200, H 1100



E27



4x 60W



9 002759 440756

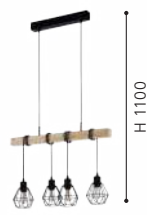

L 700

H 1100

44078 TOWNSHEND 5

wall light; steel, wood, black, brown
Wandleuchte; Stahl, Holz, schwarz, braun
Applique; acier, bois, noir, marron

L 140, H 275, A 240



E27



1x 60W



9 002759 440787



A 240

H 275



44078





44076



44077



DETAIL TOWNSHEND 5

Thanks to the long cable of the luminaire heads, the height can be adjusted individually.

Durch das lange Kabel der Leuchtenköpfe kann die Höhe individuell eingestellt werden.

Grâce au long câble des têtes de luminaire, la hauteur peut être réglée individuellement.

44076 TOWNSHEND 5

pendant light; steel, wood, black, brown
 Hängeleuchte; Stahl, Holz, schwarz, braun
 luminaire en suspension; acier, bois, noir, marron

L 1000, B 200, H 1100



E27



6x 60W



9 002759 440763



44077 TOWNSHEND 5

pendant light; steel, wood, black, brown
 Hängeleuchte; Stahl, Holz, schwarz, braun
 luminaire en suspension; acier, bois, noir, marron

L 1500, B 200, H 1100



E27



9x 60W



9 002759 440770

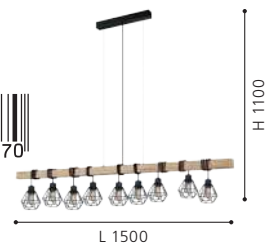



44081



44079



44094



44081 TOWNSHEND 5

floor light; steel, wood, black, brown
 Stehleuchte; Stahl, Holz, schwarz, braun
 lampadaire; acier, bois, noir, marron

L 400, B 250, H 1665, Base: Ø 250



E27 2x 60W



9 002759 440817

44079 TOWNSHEND 5

table light; steel, wood, black, brown
 Tischleuchte; Stahl, Holz, schwarz, braun
 luminaire de table; acier, bois, noir, marron

L 220, B 155, H 500, Base: Ø 155



E27 1x 60W



9 002759 440794

44094 PALMORLA

pendant light; steel, wood, black, brown
 Hängeleuchte; Stahl, Holz, schwarz, braun
 luminaire en suspension; acier, bois, noir, marron

L 760, B 160, H 1100



E27 3x 60W



9 002759 440947

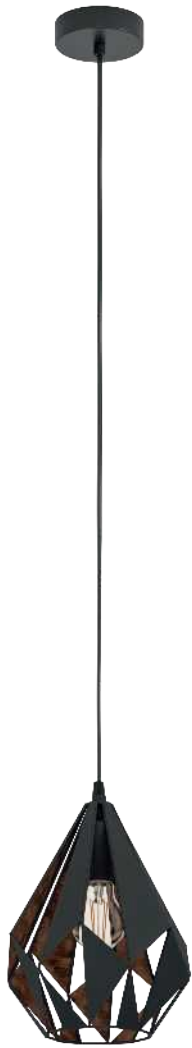

49997

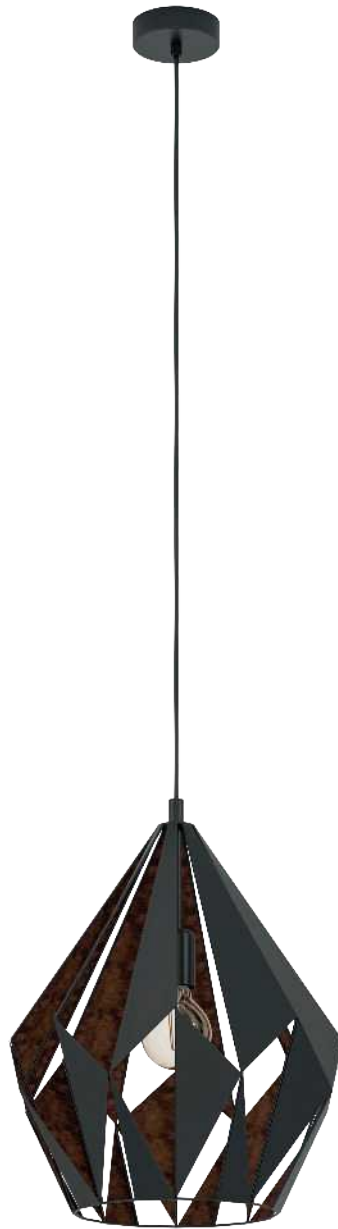

49878

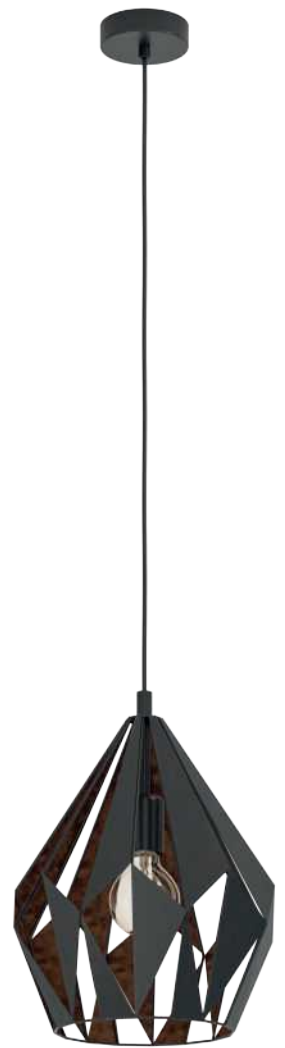

49254

49997 CARLTON 1

pendant light; steel, black, copper
Hängeleuchte; Stahl, schwarz, kupfer
luminaire en suspension; acier, noir, cuivre

H 1100, Ø 205



E27 1x 60W



9 002759 499976

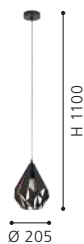

49878 CARLTON 1

pendant light; steel, black, copper
Hängeleuchte; Stahl, schwarz, kupfer
luminaire en suspension; acier, noir, cuivre

H 1500, Ø 385



E27 1x 60W



9 002759 498788



49254 CARLTON 1

pendant light; steel, black, copper
Hängeleuchte; Stahl, schwarz, kupfer
luminaire en suspension; acier, noir, cuivre

H 1100, Ø 310



E27 1x 60W



9 002759 492540





49991

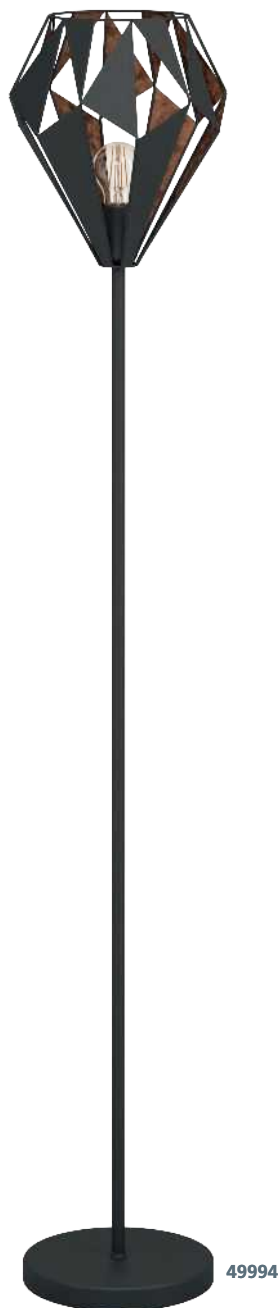

49994



49992

DETAIL 49992

This wall luminaires can be mounted with the head up and down.

Diese Wandleuchten können mit dem Kopf nach oben und unten montiert werden.

Cette appliques peuvent être montée avec la tête en haut ou en bas.



49991 CARLTON 1

pendant light; steel, black, copper
Hängeleuchte; Stahl, schwarz, kupfer
luminaire en suspension; acier, noir, cuivre

L 805, B 205, H 1100



E27 3x 60W



9 002759 499914



49994 CARLTON 1

floor light; steel, black, copper
Stehleuchte; Stahl, schwarz, kupfer
lampadaire; acier, noir, cuivre

H 1525, Ø 255, Base: Ø 230



E27 1x 60W



9 002759 499945



49992 CARLTON 1

wall light; steel, black, copper
Wandleuchte; Stahl, schwarz, kupfer
Applique; acier, noir, cuivre

L 205, H 330, A 220



E27 1x 60W



9 002759 499921





43846



43716

43846 CARLTON 1

pendant light; steel, black, copper
Hängeleuchte; Stahl, schwarz, kupfer
luminaire en suspension; acier, noir, cuivre

L 1455, B 385, H 1070



E27



6x 40W



9 002759 438463



L 1455

H 1070

43716 CARLTON 7

spot; steel, black, antique copper coloured
Spot; Stahl, schwarz, kupferfarben-antik
spot; acier, noir, aspect cuivre-antique

L 420, B 160, H 255



E27



2x 40W



9 002759 437169



L 420

H 255



43717



43718



43715

43717 CARLTON 7

spot; steel, black, antique copper coloured
Spot; Stahl, schwarz, kupferfarben-antik
spot; acier, noir, aspect cuivre-antique

L 730, B 160, H 255



E27



3x 40W



9 002759 437176



L 730

H 255

43715 CARLTON 7

spot; steel, black, antique copper coloured
Spot; Stahl, schwarz, kupferfarben-antik
spot; acier, noir, aspect cuivre-antique

Ø 160, A 255



E27



1x 40W



9 002759 437152



A 255

Ø 160

43718 CARLTON 7

spot; steel, black, antique copper coloured
Spot; Stahl, schwarz, kupferfarben-antik
spot; acier, noir, aspect cuivre-antique

L 370, B 370, H 255



E27



4x 40W



9 002759 437183



L 370

B 370



43057



43399



43058

43057 CARLTON 4

wall light; steel, black, antique copper coloured
Wandleuchte; Stahl, schwarz, kupferfarben-antik
Applique; acier, noir, aspect cuivre-antique

L 160, H 315, A 225



E27 1x 60W



9 002759 430573



43058 CARLTON 4

table light; steel, black, antique copper coloured
Tischleuchte; Stahl, schwarz, kupferfarben-antik
luminaire de table; acier, noir, aspect cuivre-antique

L 220, B 160, H 505, Base: Ø 170



E27 1x 60W



9 002759 430580



43399 CARLTON 6

ceiling light; steel, black, copper
Deckenleuchte; Stahl, schwarz, kupfer
plafonnier; acier, noir, cuivre

H 235, Ø 470



E27 1x 60W



9 002759 433994





43077

43077 CARLTON 5

table light; steel, black, copper / fabric, black, copper
Tischleuchte; Stahl, schwarz, kupfer / Textil, schwarz, kupfer
luminaire de table; acier, noir, cuivre / tissu, noir, cuivre

H 510, Ø 250



E27



1x 60W



9 002759 430771



49932



43002

49932 CARLTON 1

pendant light; steel, white, honey gold
Hängeleuchte; Stahl, weiss, honiggold
luminaire en suspension; acier, blanc, or

H 1100, Ø 310



E27 1x 60W



9 002759 499327



43002 CARLTON 1

pendant light; steel, white, gold
Hängeleuchte; Stahl, weiss, gold
luminaire en suspension; acier, blanc, or

L 805, B 205, H 1100



E27 3x 60W



9 002759 430023



43001 CARLTON 1

pendant light; steel, white, gold
Hängeleuchte; Stahl, weiss, gold
luminaire en suspension; acier, blanc, or

H 1100, Ø 205



E27 1x 60W



9 002759 430016





43001





49024



49026

49024 CARLTON-P

pendant light; steel, pastel apricot
Hängeleuchte; Stahl, Pastell apricot
luminaire en suspension; acier, Pastel abricot

H 1500, Ø 310



E27 1x 60W



9 002759 490249



49026 CARLTON-P

pendant light; steel, pastel light green
Hängeleuchte; Stahl, Pastell hellgrün
luminaire en suspension; acier, pastel vert clair

H 1500, Ø 310



E27 1x 60W



9 002759 490263



49931 CARLTON 1

pendant light; steel, black, gold
Hängeleuchte; Stahl, schwarz, gold
luminaire en suspension; acier, noir, or

H 1100, Ø 310



E27 1x 60W



9 002759 499310





49931



43909



43908

43909 CARLTON

pendant light; steel, gold-coloured
Hängeleuchte; Stahl, goldfarben
luminaire en suspension; acier, or

L 805, B 205, H 1100



E27



3x 60W



9 002759 439095

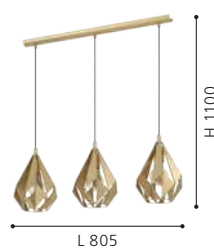

43908 CARLTON

ceiling light; steel, gold-coloured
Deckenleuchte; Stahl, goldfarben
plafonnier; acier, or

H 235, Ø 470



E27



1x 60W



9 002759 439088





43815

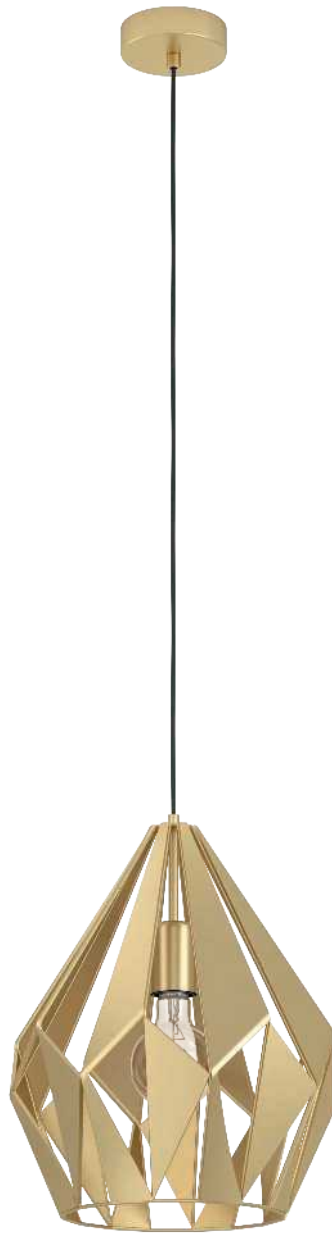

43814

43815 CARLTON

pendant light; steel, gold-coloured
Hängeleuchte; Stahl, goldfarben
luminaire en suspension; acier, or

H 1100, Ø 385



E27



1x 60W



9 002759 438159



43814 CARLTON

pendant light; steel, gold-coloured
Hängeleuchte; Stahl, goldfarben
luminaire en suspension; acier, or

H 1100, Ø 310



E27



1x 60W



9 002759 438142





49258



49259



49933

49258 CARLTON

pendant light; steel, copper-coloured
Hängeleuchte; Stahl, kupferfarben
luminaire en suspension; acier, cuivré

H 1100, Ø 310



E27 1x 60W



9 002759 492588



49259 CARLTON

pendant light; steel, mint
Hängeleuchte; Stahl, mint
luminaire en suspension; acier, menthe

H 1100, Ø 310



E27 1x 60W



9 002759 492595

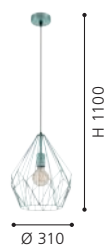

49933 CARLTON

pendant light; steel, gold-coloured
Hängeleuchte; Stahl, goldfarben
luminaire en suspension; acier, or

H 1100, Ø 310



E27 1x 60W



9 002759 499334





49257 CARLTON

pendant light; steel, black
Hängeleuchte; Stahl, schwarz
luminaire en suspension; acier, noir

H 1100, Ø 310



E27



1x 60W



9 002759 492571



DESIGN
HIGHLIGHT
DETAIL





43692

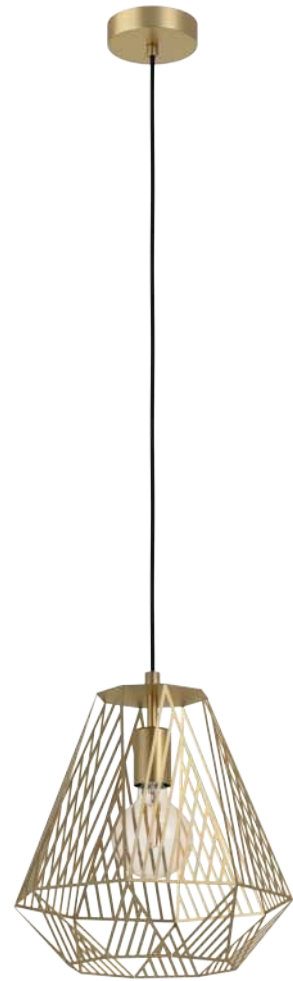

43695

43692 STYPE

pendant light; steel, black
 Hängeleuchte; Stahl, schwarz
 luminaire en suspension; acier, noir

H 1100, Ø 330



E27



1x 40W



9 002759 436926



43695 STYPE

pendant light; steel, gold-coloured
 Hängeleuchte; Stahl, goldfarben
 luminaire en suspension; acier, or

H 1100, Ø 330



E27



1x 40W



9 002759 436957





43696



43693

43696 STYPE

pendant light; steel, gold-coloured
Hängeleuchte; Stahl, goldfarben
luminaire en suspension; acier, or

L 960, B 200, H 1100



E27



3x 40W



9 002759 436964



L 960

H 1100

43693 STYPE

pendant light; steel, black
Hängeleuchte; Stahl, schwarz
luminaire en suspension; acier, noir

L 960, B 200, H 1100



E27



3x 40W



9 002759 436933



L 960

H 1100



43359



43361

43359 STRAITON

pendant light; steel, black
Hängeleuchte; Stahl, schwarz
luminaire en suspension; acier, noir

H 1100, Ø 515



E27 1x 60W



9 002759 433598

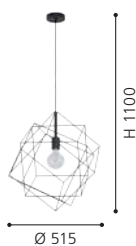

43361 STRAITON

pendant light; steel, black
Hängeleuchte; Stahl, schwarz
luminaire en suspension; acier, noir

L 905, B 240, H 1100



E27 3x 60W



9 002759 433611

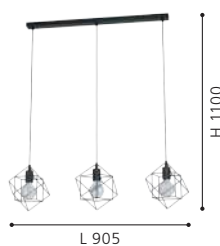

43358 STRAITON

pendant light; steel, black
Hängeleuchte; Stahl, schwarz
luminaire en suspension; acier, noir

L 240, B 205, H 1100



E27 1x 60W



9 002759 433581

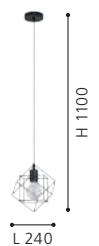



43358



43481



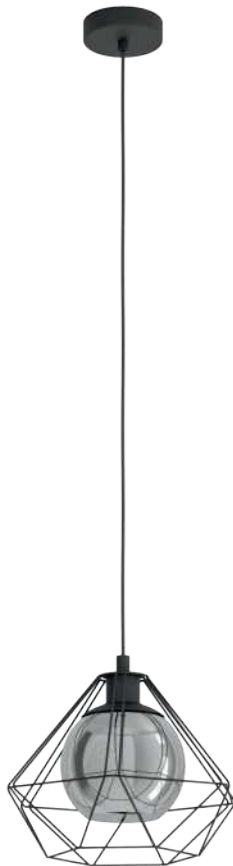

43482



43483

43481 VERNHAM

pendant light; steel, black / glass vaporized, black-transparent
 Hängeleuchte; Stahl, schwarz / Glas bedampft, schwarz-transparent
 luminaire en suspension; acier, noir / verre vaporisé, noir transparent

H 1100, Ø 445



E27



1x 40W



9 002759 434816

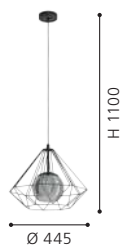

43482 VERNHAM

pendant light; steel, black / glass vaporized, black-transparent
 Hängeleuchte; Stahl, schwarz / Glas bedampft, schwarz-transparent
 luminaire en suspension; acier, noir / verre vaporisé, noir transparent

H 1100, Ø 325



E27



1x 40W



9 002759 434823



43483 VERNHAM

pendant light; steel, black / glass vaporized, black-transparent
 Hängeleuchte; Stahl, schwarz / Glas bedampft, schwarz-transparent
 luminaire en suspension; acier, noir / verre vaporisé, noir transparent

L 1145, B 325, H 1100



E27



3x 40W



9 002759 434830

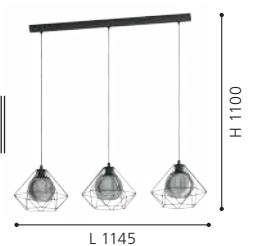



43004



49081

DESIGN
HIGHLIGHT
DETAIL



43004 TARBES

ceiling light; steel, black
Deckenleuchte; Stahl, schwarz
plafonnier; acier, noir

H 275, Ø 325



E27 1x 60W



9 002759 430047



49081 TARBES

wall light; steel, black
Wandleuchte; Stahl, schwarz
Applique; acier, noir

L 155, H 375, A 275



E27 1x 60W



9 002759 490812



49487 CARLTON 2

pendant light; steel, black
Hängeleuchte; Stahl, schwarz
luminaire en suspension; acier, noir

H 1100, Ø 455



E27 1x 60W



9 002759 494872





49487



43766

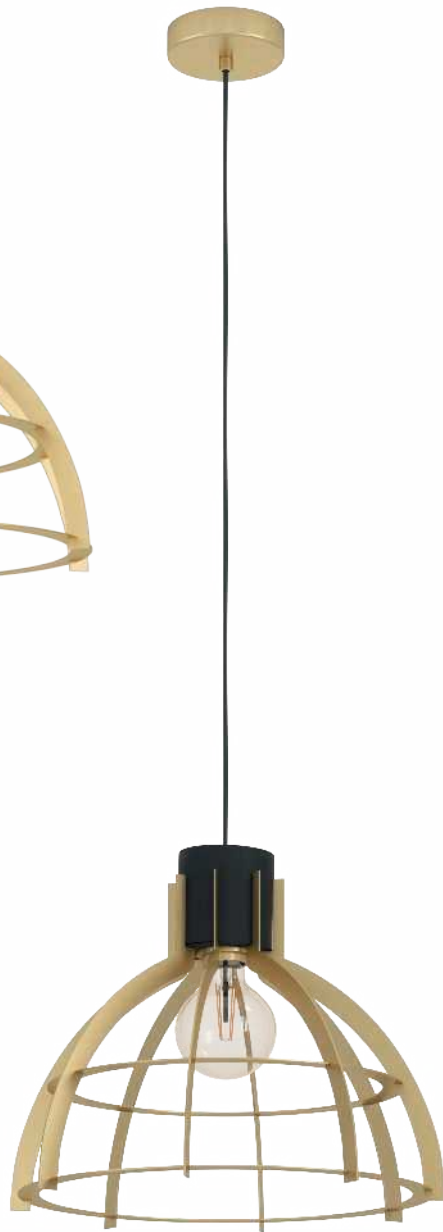

43767

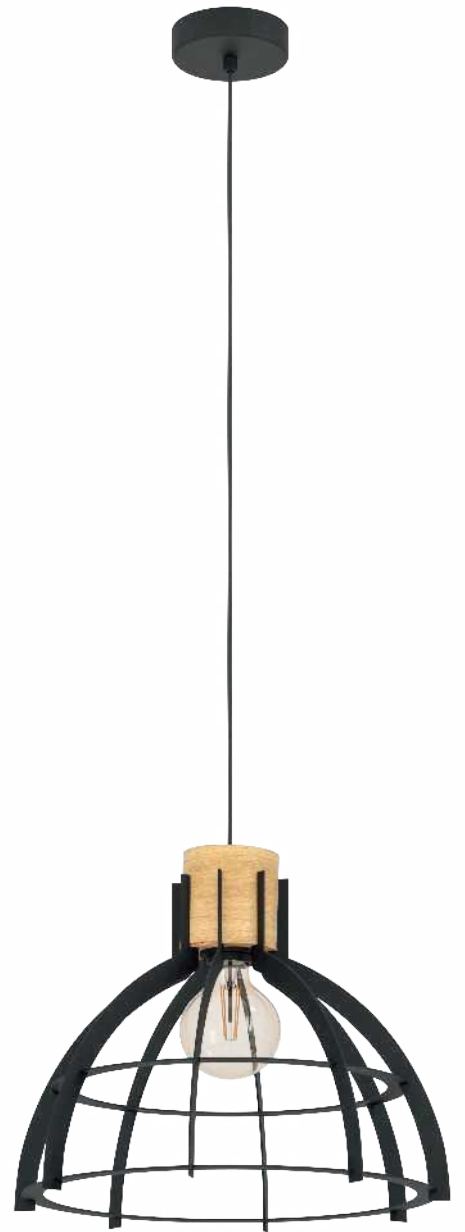

43769

43766 STILLINGTON

ceiling light; steel, black, gold
Deckenleuchte; Stahl, schwarz, gold
plafonnier; acier, noir, or

H 315, Ø 415



E27 1x 40W



9 002759 437664



43767 STILLINGTON

pendant light; steel, black, gold
Hängeleuchte; Stahl, schwarz, gold
luminaire en suspension; acier, noir, or

H 1100, Ø 415



E27 1x 40W



9 002759 437671



43769 STILLINGTON

pendant light; steel, wood, black, brown
Hängeleuchte; Stahl, Holz, schwarz, braun
luminaire en suspension; acier, bois, noir, marron

H 1100, Ø 415



E27 1x 40W



9 002759 437695





43768

43768 STILLINGTON

ceiling light; steel, wood, black, brown
Deckenleuchte; Stahl, Holz, schwarz, braun
plafonnier; acier, bois, noir, marron

H 315, Ø 415



E27



1x 40W



9 002759 437688

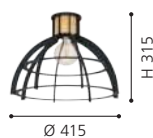



43928



43926



43927



43926 STILLINGTON 1

spot; steel, wood, black, brown
Spot; Stahl, Holz, schwarz, braun
spot; acier, bois, noir, marron

H 245, Ø 160



E27



1x 40W



9 002759 439262

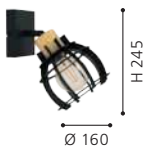

43928 STILLINGTON 1

spot; steel, wood, black, brown
Spot; Stahl, Holz, schwarz, braun
spot; acier, bois, noir, marron

L 710, B 160, H 245



E27



3x 40W



9 002759 439286



43927 STILLINGTON 1

spot; steel, wood, black, brown
Spot; Stahl, Holz, schwarz, braun
spot; acier, bois, noir, marron

L 420, B 160, H 245



E27



2x 40W



9 002759 439279





43925



43925 STILLINGTON 1

pendant light; steel, wood, black, brown
Hängeleuchte; Stahl, Holz, schwarz, braun
luminaire en suspension; acier, bois, noir, marron

L 880, B 180, H 1100



E27



3x 40W



9 002759 439255



DESIGN
HIGHLIGHT
DETAIL



43819



43818



43817

43819 SOUTHERY

spot; steel, brushed creme-gold, white
Spot; Stahl, creme-gold gebürstet, weiss
spot; acier, or crème brossé, blanc

L 700, B 110, H 210



E27 3x 40W



9 002759 438197



L 700

43818 SOUTHERY

spot; steel, brushed creme-gold, white
Spot; Stahl, creme-gold gebürstet, weiss
spot; acier, or crème brossé, blanc

L 470, B 110, H 210



E27 2x 40W



9 002759 438180



L 470

43817 SOUTHERY

spot; steel, brushed creme-gold, white
Spot; Stahl, creme-gold gebürstet, weiss
spot; acier, or crème brossé, blanc

L 185, B 110, H 210



E27 1x 40W



9 002759 438173

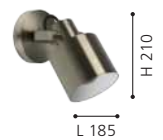

L 185



43816

43816 SOUTHERY

pendant light; steel, brushed creme-gold, white
Hängeleuchte; Stahl, creme-gold gebürstet, weiss
luminaire en suspension; acier, or crème brossé, blanc

H 1100, Ø 350



E27



1x 40W



9 002759 438166





44028



DETAIL LINTMILL

The brushed brass shade is adjustable.
Die gebürstete Messingscheibe ist verstellbar.
Le disque en laiton brossé est réglable.



44027

44028 LINTMILL

wall/ceiling light; steel, black / glass, grey
Wand- / Deckenleuchte; Stahl, schwarz / Glas, grau
Applique/Plafonnier; acier, noir / verre, gris

H 75, Ø 300



E27 1x 40W



9 002759 440282

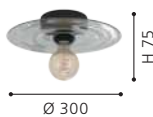

44027 LINTMILL

ceiling light; steel, black, brushed brass / glass, grey
Deckenleuchte; Stahl, schwarz, messing-gebürstet / Glas, grau
plafonnier; acier, noir, laiton brossé / verre, gris

H 200, Ø 530



E27 3x 40W



9 002759 440275

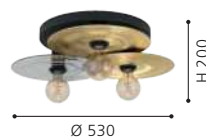

44029 LINTMILL

pendant light; steel, black / steel, brushed brass
Hängeleuchte; Stahl, schwarz / Stahl, messing-gebürstet
luminaire en suspension; acier, noir / acier, laiton brossé

H 1100, Ø 400



E27 1x 40W



9 002759 440299

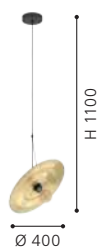



44029



43443



DETAIL 43599

These ceiling luminaires have a great play of light.

Diese Deckenleuchten verfügen über ein tolles Lichtspiel.

Ces plafonniers disposent d'un superbe jeu de lumière.

43443 CASTANUELO

wall/ceiling light; steel, gold
Wand- / Deckenleuchte; Stahl, gold
Applique/Plafonnier; acier, or

H 105, Ø 425



E27



1x 40W



9 002759 434434

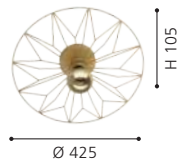



43599



43808



43809

43599 CASTANUELO

wall/ceiling light; steel, gold
Wand- / Deckenleuchte; Stahl, gold
Applique/Plafonnier; acier, or

H 100, Ø 425



E27



1x 40W



9 002759 435998



H 100

Ø 425

43808 CASTANUELO

table light; steel, black, gold
Tischleuchte; Stahl, schwarz, gold
luminaire de table; acier, noir, or

L 370, B 270, H 575, Base: Ø 295



E27



1x 40W



9 002759 438081

L 370



H 575

Ø 295

43809 CASTANUELO

floor light; steel, black, gold
Stehleuchte; Stahl, schwarz, gold
lampadaire; acier, noir, or

L 500, B 270, H 1520, Base: Ø 745



E27



1x 40W



9 002759 438098

L 500



H 1520

Ø 745



43679

43679 TARBES

pendant light; steel, brushed brass
Hängeleuchte; Stahl, messing-gebürstet
luminaire en suspension; acier, laiton brossé

H 1100, Ø 325



E27



1x 60W



9 002759 436797





43678



43681



43682

43678 TARDES

ceiling light; steel, brushed brass
Deckenleuchte; Stahl, messing-gebürstet
plafonnier; acier, laiton brossé

H 275, Ø 325



E27



1x 60W



9 002759 436780



Ø 325

H 275

43681 TARDES

pendant light; steel, brushed brass
Hängeleuchte; Stahl, messing-gebürstet
luminaire en suspension; acier, laiton brossé

H 1300, Ø 175



E27



1x 60W



9 002759 436810



Ø 175

H 1300

43682 TARDES

pendant light; steel, brushed brass
Hängeleuchte; Stahl, messing-gebürstet
luminaire en suspension; acier, laiton brossé

L 795, B 175, H 1300



E27



3x 60W



9 002759 436827



L 795

H 1300



94191

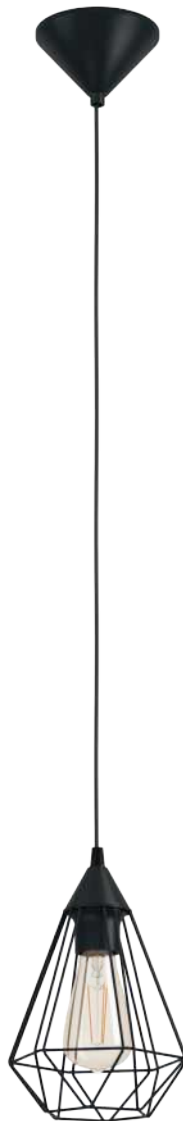

94187

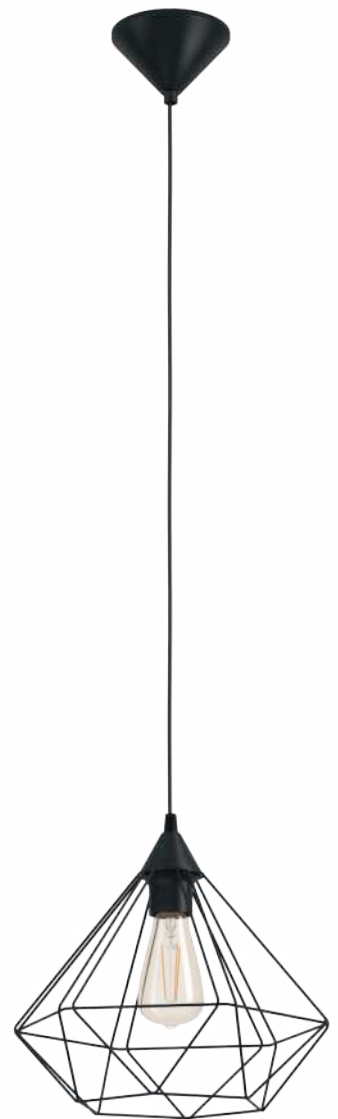

94188

94191 TARBES

pendant light; steel, black / steel, black
 Hängeleuchte; Stahl, schwarz / Stahl, schwarz
 luminaire en suspension; acier, noir / acier, noir

H 1100, Ø 310



E27 3x 60W



9 002759 941918



94187 TARBES

pendant light; plastic, black / steel, black
 Hängeleuchte; Kunststoff, schwarz / Stahl, schwarz
 luminaire en suspension; plastique, noir / acier, noir

H 1100, Ø 175



E27 1x 60W



9 002759 941871



94188 TARBES

pendant light; plastic, black / steel, black
 Hängeleuchte; Kunststoff, schwarz / Stahl, schwarz
 luminaire en suspension; plastique, noir / acier, noir

H 1100, Ø 325



E27 1x 60W



9 002759 941888

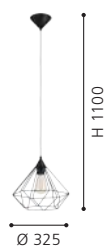



94189



94192

94189 TARBES

pendant light; steel, black / steel, black
 Hängeleuchte; Stahl, schwarz / Stahl, schwarz
 luminaire en suspension; acier, noir / acier, noir

L 790, B 175, H 1100



E27



3x 60W



9 002759 941895



L 790

H 1100

94192 TARBES

table light; steel, black / steel, black
 Tischleuchte; Stahl, schwarz / Stahl, schwarz
 luminaire de table; acier, noir / acier, noir

H 265, Ø 175



E27



1x 60W



9 002759 941925



H 265

Ø 175



94194

94195

94194 TARBES

pendant light; plastic, black / steel, copper-coloured
 Hängeleuchte; Kunststoff, schwarz / Stahl, kupferfarben
 luminaire en suspension; plastique, noir / acier, cuivré

H 1100, Ø 325



E27 1x 60W



94195 TARBES

pendant light; steel, black / steel, copper-coloured
 Hängeleuchte; Stahl, schwarz / Stahl, kupferfarben
 luminaire en suspension; acier, noir / acier, cuivré

L 790, B 175, H 1100



E27 3x 60W

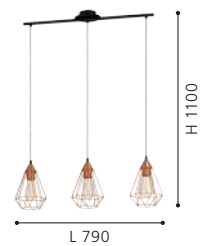



94196



94193

94196 TARBES

pendant light; steel, black / steel, copper-coloured
Hängeleuchte; Stahl, schwarz / Stahl, kupferfarben
luminaire en suspension; acier, noir / acier, cuivré

H 1100, Ø 310



E27



3x 60W



9 002759 941963

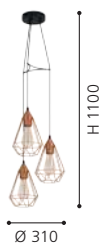

H 1100

Ø 310

94193 TARBES

pendant light; plastic, black / steel, copper-coloured
Hängeleuchte; Kunststoff, schwarz / Stahl, kupferfarben
luminaire en suspension; plastique, noir / acier, cuivré

H 1100, Ø 175



E27



1x 60W



9 002759 941932



H 1100

Ø 175



49644

49645

49646

49644 ROCCAMENA

pendant light; steel, black, copper
 Hängeleuchte; Stahl, schwarz, kupfer
 luminaire en suspension; acier, noir, cuivre

H 1100, Ø 130



E27 1x 60W



9 002759 496449

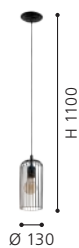

49645 ROCCAMENA

pendant light; steel, black, copper
 Hängeleuchte; Stahl, schwarz, kupfer
 luminaire en suspension; acier, noir, cuivre

L 730, B 130, H 1100



E27 3x 60W



9 002759 496456



49646 ROCCAMENA

table light; steel, black, copper
 Tischleuchte; Stahl, schwarz, kupfer
 luminaire de table; acier, noir, cuivre

H 310, Ø 130, Base: Ø 130

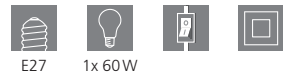

E27 1x 60W



9 002759 496463





49142

49142 CLEVEDON

pendant light; steel, black
Hängeleuchte; Stahl, schwarz
luminaire en suspension; acier, noir

L 780, B 170, H 1100



E27



3x 60W



9 002759 491420

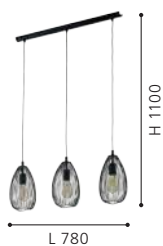



49472



49477

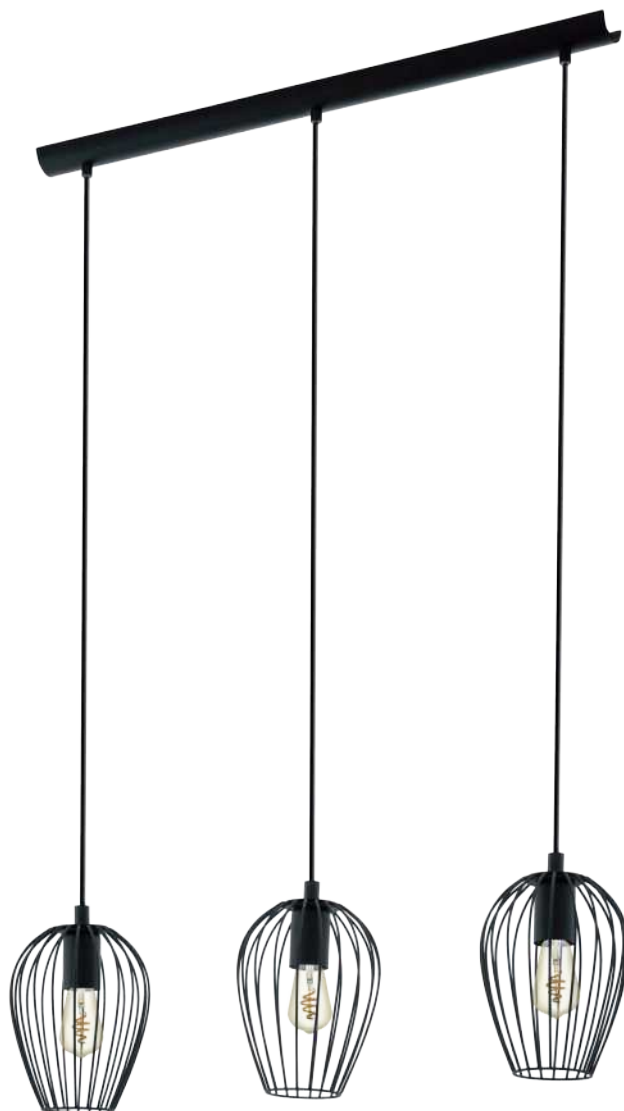

49478

49472 NEWTOWN

pendant light; steel, black
Hängeleuchte; Stahl, schwarz
luminaire en suspension; acier, noir

H 1100, Ø 275



E27



1x 60W



9 002759 494728



49477 NEWTOWN

pendant light; steel, black
Hängeleuchte; Stahl, schwarz
luminaire en suspension; acier, noir

H 1100, Ø 160



E27



1x 60W



9 002759 494773



49478 NEWTOWN

pendant light; steel, black
Hängeleuchte; Stahl, schwarz
luminaire en suspension; acier, noir

L 700, B 160, H 1100



E27



3x 60W



9 002759 494780





49479



49481



49474

49479 NEWTOWN

pendant light; steel, black
Hängeleuchte; Stahl, schwarz
luminaire en suspension; acier, noir

H 1300, Ø 380



E27



3x 60W



9 002759 494797



49481 NEWTOWN

table light; steel, black
Tischleuchte; Stahl, schwarz
luminaire de table; acier, noir

H 230, Ø 160, Base: Ø 120



E27



1x 60W



9 002759 494810



49474 NEWTOWN

floor light; steel, black
Stehleuchte; Stahl, schwarz
lampadaire; acier, noir

H 1595, Ø 275, Base: Ø 230



E27



1x 60W



9 002759 494742



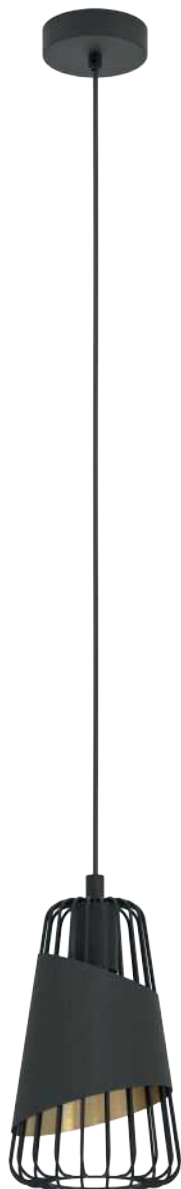

49447



49448

49447 AUSTELL

pendant light; steel, black / steel, fabric, black, gold
 Hängeleuchte; Stahl, schwarz / Stahl, Textil, schwarz, gold
 luminaire en suspension; acier, noir / acier, tissu, noir, or

H 1100, Ø 165



E27 1x 60W



9 002759 494476

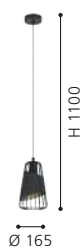

49448 AUSTELL

pendant light; steel, black / steel, fabric, black, gold
 Hängeleuchte; Stahl, schwarz / Stahl, Textil, schwarz, gold
 luminaire en suspension; acier, noir / acier, tissu, noir, or

L 765, B 165, H 1100



E27 3x 60W



9 002759 494483



49446 AUSTELL

pendant light; steel, black / steel, fabric, black, gold
 Hängeleuchte; Stahl, schwarz / Stahl, Textil, schwarz, gold
 luminaire en suspension; acier, noir / acier, tissu, noir, or

H 1100, Ø 360



E27 1x 60W



9 002759 494469





49446



43848





43847



43849



43848 PLIMSOLL

pendant light; steel, wood, black
Hängeleuchte; Stahl, Holz, schwarz
luminaire en suspension; acier, bois, noir

L 770, B 95, H 1100



E27



4x 15W



9 002759 438487

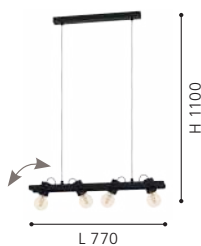

43847 PLIMSOLL

ceiling light; steel, wood, black
Deckenleuchte; Stahl, Holz, schwarz
plafonnier; acier, bois, noir

L 770, B 95, H 165



E27



4x 15W



9 002759 438470



43849 PLIMSOLL

table light; steel, wood, black
Tischleuchte; Stahl, Holz, schwarz
luminaire de table; acier, bois, noir

L 105, B 75, H 255, Base: Ø 135



E27



1x 15W



9 002759 438494





44006



44005



44007

44006 WAVERTON

pendant light; steel, black / fabric, wood, white, black
 Hängeleuchte; Stahl, schwarz / Textil, Holz, weiss, schwarz
 luminaire en suspension; acier, noir / tissu, bois, blanc, noir

H 1100, Ø 480



E27 1x 40W



9 002759 440060



44005 WAVERTON

pendant light; steel, black / fabric, wood, white, black
 Hängeleuchte; Stahl, schwarz / Textil, Holz, weiss, schwarz
 luminaire en suspension; acier, noir / tissu, bois, blanc, noir

H 1100, Ø 400



E27 1x 40W



9 002759 440053



44007 WAVERTON

pendant light; steel, black / fabric, wood, white, black
 Hängeleuchte; Stahl, schwarz / Textil, Holz, weiss, schwarz
 luminaire en suspension; acier, noir / tissu, bois, blanc, noir

L 920, B 220, H 1100



E27 3x 40W



9 002759 440077

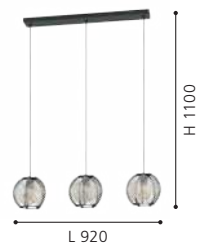



44008



44009

44008 WAVERTON

table light; steel, black / fabric, wood, white, black
 Tischleuchte; Stahl, schwarz / Textil, Holz, weiss, schwarz
 luminaire de table; acier, noir / tissu, bois, blanc, noir

H 400, Ø 220, Base: Ø 225



E27 1x 40W



9 002759 440084



Ø 225

44009 WAVERTON

floor light; steel, black / fabric, wood, white, black
 Stehleuchte; Stahl, schwarz / Textil, Holz, weiss, schwarz
 lampadaire; acier, noir / tissu, bois, blanc, noir

H 1430, Ø 400, Base: Ø 665



E27 1x 40W



9 002759 440091



Ø 665



43426



43427



DETAIL HORNWOOD 1

The heads can be adjusted or fixed in position with the lateral screws.
Die Köpfe können mittels den seitlichen Schrauben verstellt oder fixiert werden.
Les têtes peuvent être réglées ou fixées à l'aide des vis latérales.

43426 HORNWOOD 1

pendant light; steel, wood, black / fabric, white
Hängeleuchte; Stahl, Holz, schwarz / Textil, weiss
luminaire en suspension; acier, bois, noir / tissu, blanc

L 780, B 195, H 1100



E27



3x 28W



9 002759 434267

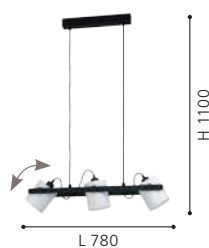

43427 HORNWOOD 1

wall light; steel, wood, black / fabric, white
Wandleuchte; Stahl, Holz, schwarz / Textil, weiss
Applique; acier, bois, noir / tissu, blanc

L 195, A 255



E27



1x 28W



9 002759 434274





44098



44114



44115



44098 BIDFORD

floor light; wood, steel, brown / fabric, cappuccino, gold
 Stehleuchte; Holz, Stahl, braun / Textil, cappuccino, gold
 lampadaire; bois, acier, marron / tissu, cappuccino, or

H 1540, Ø 460, Base: Ø 700



E27 1x 60W



9 002759 440985

44114 LANTADA

floor light; wood, steel, natural / fabric, beige
 Stehleuchte; Holz, Stahl, natur / Textil, beige
 lampadaire; bois, acier, naturel / tissu, beige

H 1430, Ø 450, Base: Ø 975

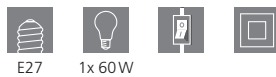

E27 1x 60W



9 002759 441142

44115 LANTADA

floor light; wood, steel, nut / fabric, taupe
 Stehleuchte; Holz, Stahl, nuss / Textil, taupe
 lampadaire; bois, acier, noisette / tissu, taupe

H 1430, Ø 450, Base: Ø 975

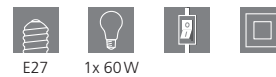

E27 1x 60W



9 002759 441159



49386



49519



DESIGN
HIGHLIGHT
DETAIL

49386 CHESTER

floor light; steel, black, copper
Stehleuchte; Stahl, schwarz, kupfer
lampadaire; acier, noir, cuivre

H 1495, Base: Ø 600



E27



1x 60W

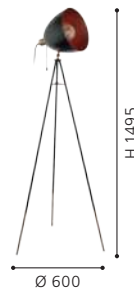

9 002759 493868

49519 CHESTER 1

floor light; steel, rust-coloured, gold
Stehleuchte; Stahl, rostfarben, gold
lampadaire; acier, rouille, or

H 1495, Base: Ø 600



E27



1x 60W

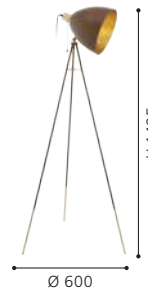

9 002759 495190

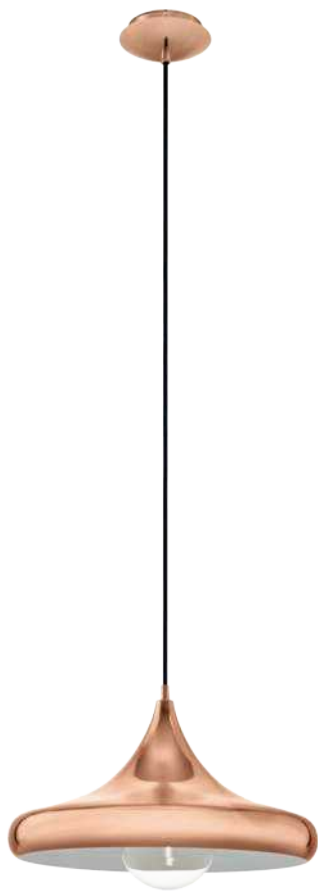

94742



49449

94742 CORETTO 2

pendant light; steel, copper
Hängeleuchte; Stahl, kupfer
luminaire en suspension; acier, cuivre

H 1100, Ø 400



E27



1x 60W



9 002759 947422

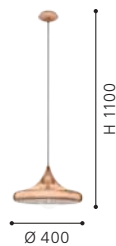

49449 HAPTON

pendant light; steel, copper
Hängeleuchte; Stahl, kupfer
luminaire en suspension; acier, cuivre

H 1100, Ø 290



E27



1x 60W



9 002759 494490

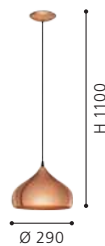



43633



43634

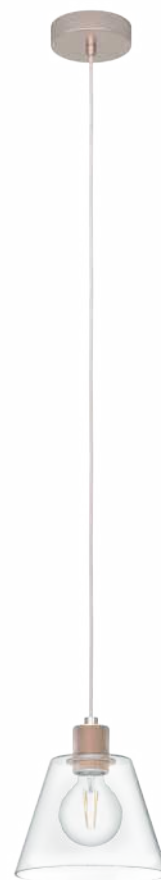

43631

43633 COPLEY

pendant light; steel, aluminium, gold-coloured / glass, clear
Hängeleuchte; Stahl, Alu, goldfarben / Glas, klar
luminaire en suspension; acier, aluminium, or / verre, transparent

H 1100, Ø 200



E27 1x 40W



9 002759 436339



43634 COPLEY

pendant light; steel, aluminium, gold-coloured / glass, clear
Hängeleuchte; Stahl, Alu, goldfarben / Glas, klar
luminaire en suspension; acier, aluminium, or / verre, transparent

L 900, B 200, H 1100



E27 3x 40W



9 002759 436346



43631 COPLEY

pendant light; steel, aluminium, rose gold / glass, clear
Hängeleuchte; Stahl, Alu, roségold / Glas, klar
luminaire en suspension; acier, aluminium, rose or / verre, transparent

H 1100, Ø 200



E27 1x 40W



9 002759 436315





43632

43632 COPLEY

pendant light; steel, aluminium, rose gold / glass, clear
Hängeleuchte; Stahl, Alu, roségold / Glas, klar
luminaire en suspension; acier, aluminium, rose or / verre,
transparent

L 900, B 200, H 1100



E27



3x 40W



9 002759 436322

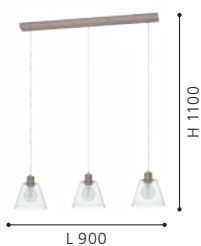

DETAIL COPLEY

These luminaires have a special socket.

Diese Leuchten verfügen über eine spezielle Fassung.

Ces luminaires disposent d'une douille spéciale.



43331



43333

43331 WRINGTON

pendant light; steel, black
Hängeleuchte; Stahl, schwarz
luminaire en suspension; acier, noir

H 1100, Ø 300



E27



1x 60W



9 002759 433314



43333 WRINGTON

pendant light; steel, black
Hängeleuchte; Stahl, schwarz
luminaire en suspension; acier, noir

L 740, B 150, H 1100



E27



3x 60W



9 002759 433338

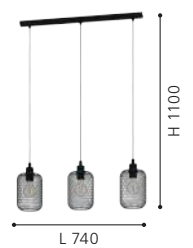



43096



32468

43096 WRINGTON

table light; steel, black
Tischleuchte; Stahl, schwarz
luminaire de table; acier, noir

H 285, Ø 150, Base: Ø 100



E27



1x 60W



9 002759 430962



32468 WRINGTON

floor light; steel, black
Stehleuchte; Stahl, schwarz
lampadaire; acier, noir

L 635, B 300, H 1940, Base: Ø 300



E27



1x 60W



9 002759 324681

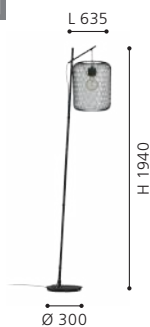



43305

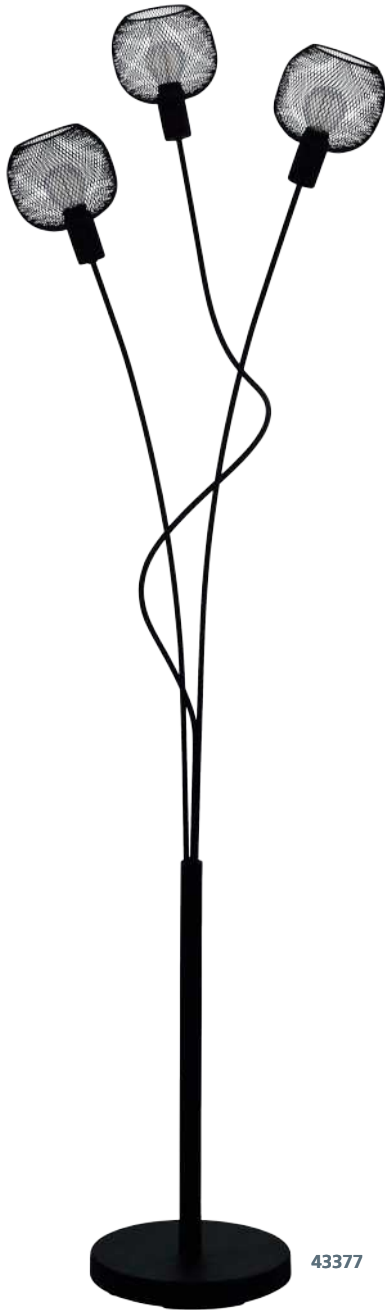

43377

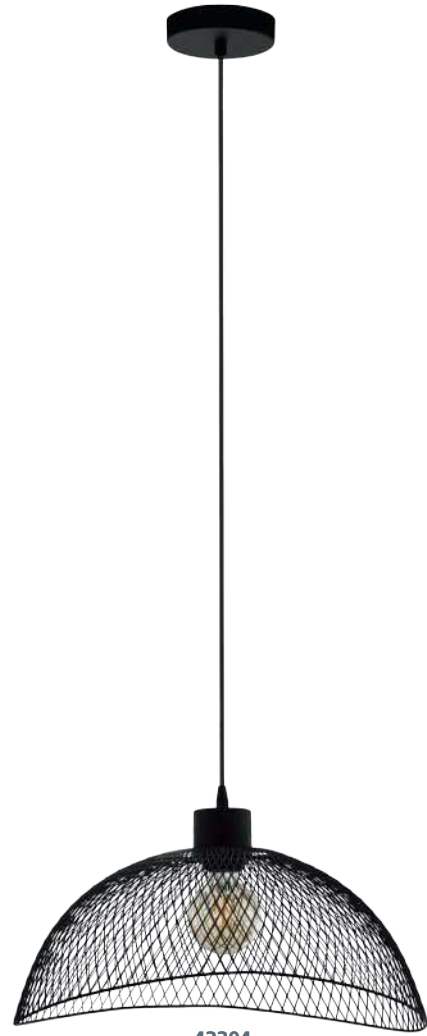

43304

43305 POMPEYA

pendant light; steel, black
Hängeleuchte; Stahl, schwarz
luminaire en suspension; acier, noir

L 570, B 540, H 1100



E27



1x 60W



9 002759 433055



43377 WRINGTON 1

floor light; steel, black
Stehleuchte; Stahl, schwarz
lampadaire; acier, noir

L 340, B 305, H 1495, Base: Ø 230



E14



3x 40W



9 002759 433772

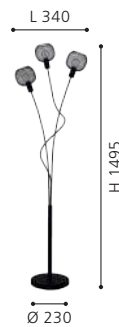

43304 POMPEYA

pendant light; steel, black
Hängeleuchte; Stahl, schwarz
luminaire en suspension; acier, noir

L 450, B 440, H 1100



E27



1x 60W



9 002759 433048





43669

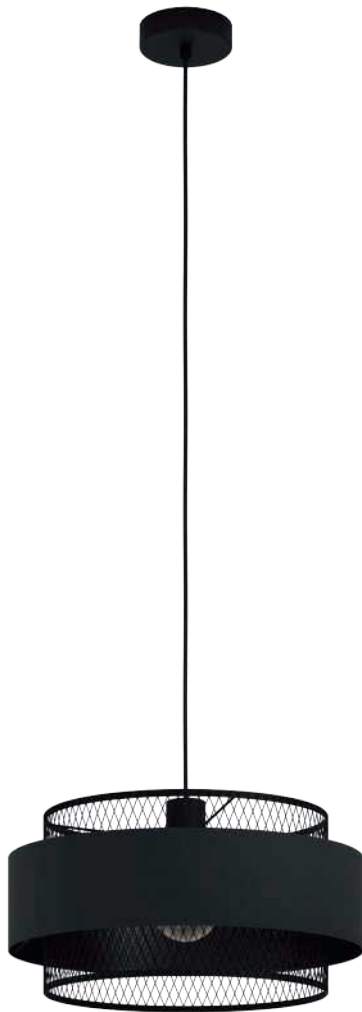

43668

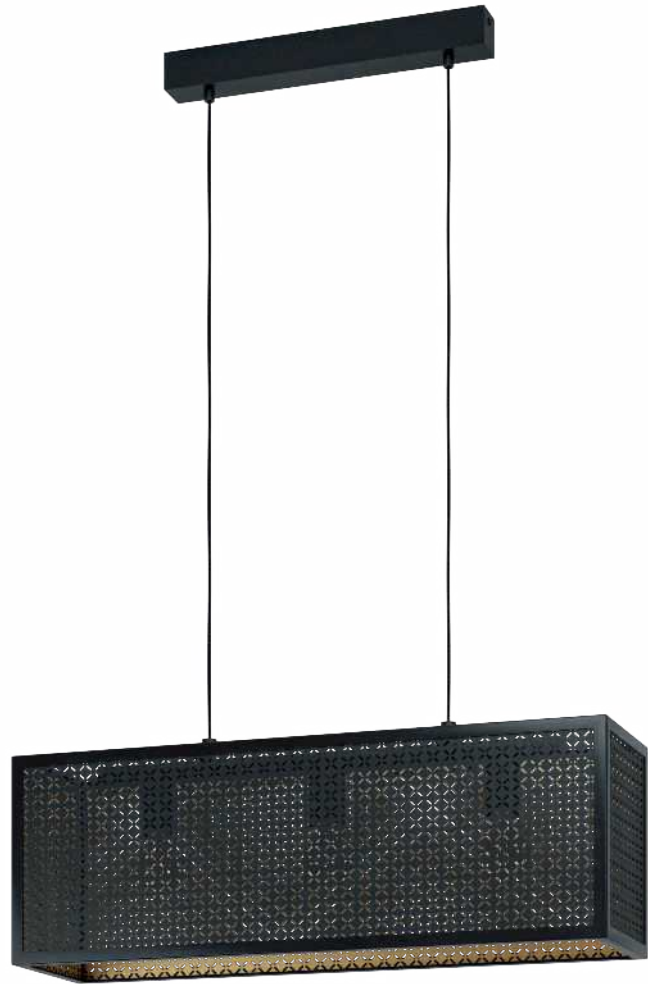

43559

43669 BAZELY

pendant light; steel, black / fabric, black
 Hängeleuchte; Stahl, schwarz / Textil, schwarz
 luminaire en suspension; acier, noir / tissu, noir

L 990, B 230, H 1100



E27



3x 40W



9 002759 436681



43668 BAZELY

pendant light; steel, black / fabric, black
 Hängeleuchte; Stahl, schwarz / Textil, schwarz
 luminaire en suspension; acier, noir / tissu, noir

H 1100, Ø 400



E27



1x 40W



9 002759 436681



43559 SALLICANO

pendant light; steel, black, gold
 Hängeleuchte; Stahl, schwarz, gold
 luminaire en suspension; acier, noir, or

L 730, B 200, H 1100



E27



3x 40W



9 002759 435592

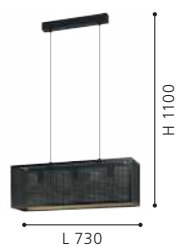

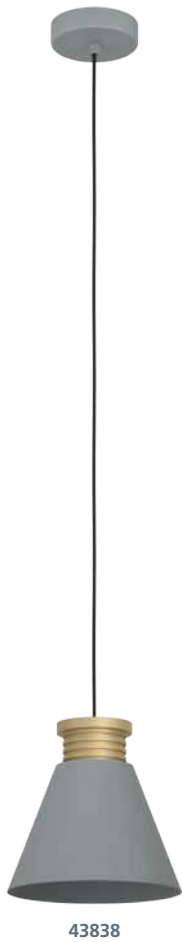

43838



43839



43841

43838 TWICKEN

pendant light; steel, grey, gold
Hängeleuchte; Stahl, grau, gold
luminaire en suspension; acier, gris, or

H 1100, Ø 220



E27 1x 40W



9 002759 438388



43839 TWICKEN

pendant light; steel, grey, gold
Hängeleuchte; Stahl, grau, gold
luminaire en suspension; acier, gris, or

L 920, B 220, H 1100



E27 3x 40W



9 002759 438395

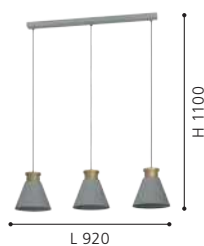

43841 TWICKEN

table light; steel, grey, gold
Tischleuchte; Stahl, grau, gold
luminaire de table; acier, gris, or

L 155, B 150, H 195, Base: B 155



E27 1x 28W



9 002759 438418





43835



43836



43837

43835 TWICKEN

spot; steel, grey, gold
Spot; Stahl, grau, gold
spot; acier, gris, or

L 180, B 150, H 200



E27



1x 28W



9 002759 438357

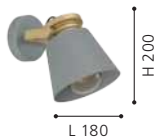

L 180

H 200

43836 TWICKEN

spot; steel, grey, gold
Spot; Stahl, grau, gold
spot; acier, gris, or

L 370, B 205, H 175



E27



2x 40W



9 002759 438364



L 370

H 175

43837 TWICKEN

spot; steel, grey, gold
Spot; Stahl, grau, gold
spot; acier, gris, or

L 590, B 205, H 175



E27



3x 40W



9 002759 438371



L 590

H 175



43825



DESIGN
HIGHLIGHT
DETAIL

43825 MATLOCK

pendant light; steel, grey, black
Hängeleuchte; Stahl, grau, schwarz
luminaire en suspension; acier, gris, noir

H 1100, Ø 380



E27



1x 40W



9 002759 438258

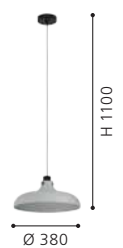

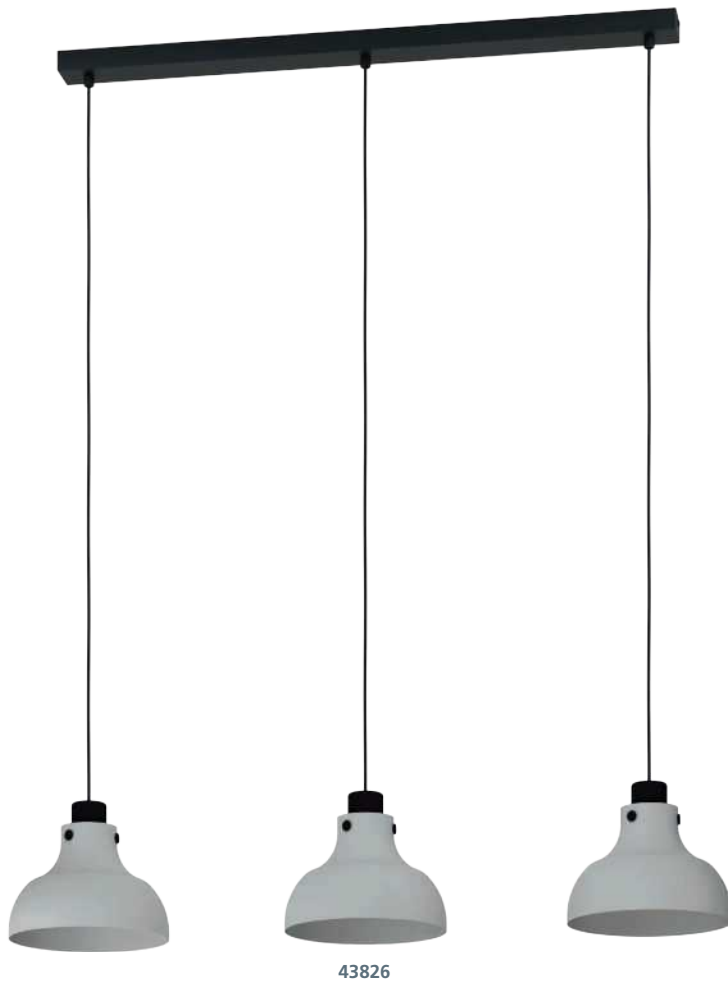

43826



43842

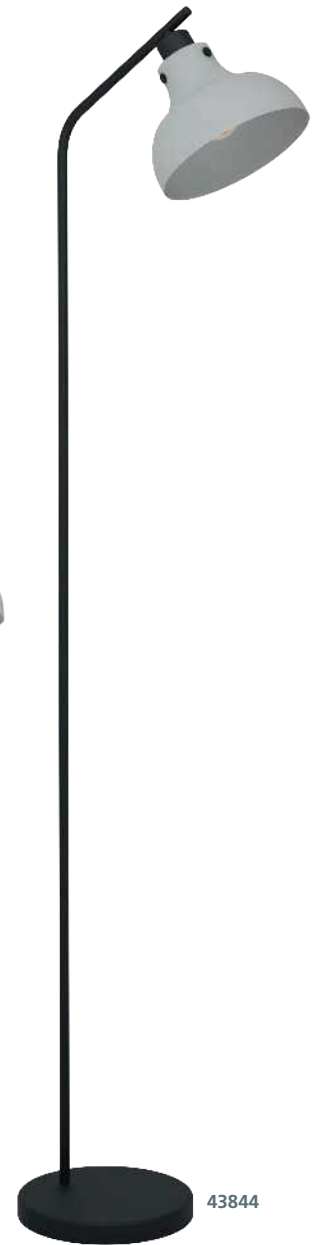

43844

43826 MATLOCK

pendant light; steel, grey, black
 Hängeleuchte; Stahl, grau, schwarz
 luminaire en suspension; acier, gris, noir

L 900, B 200, H 1100



E27 3x 40W



9 002759 438265



43842 MATLOCK

ceiling light; steel, grey, black
 Deckenleuchte; Stahl, grau, schwarz
 plafonnier; acier, gris, noir

H 210, Ø 380



E27 1x 40W



9 002759 438425



43844 MATLOCK

floor light; steel, grey, black
 Stehleuchte; Stahl, grau, schwarz
 lampadaire; acier, gris, noir

L 405, B 200, H 1580, Base: B 230



E27 1x 40W



9 002759 438449





43829



43827



43828

43829 MATLOCK

spot; steel, wood, grey, black
Spot; Stahl, Holz, grau, schwarz
spot; acier, bois, gris, noir

L 740, B 145, H 225



E27 3x 40W



9 002759 438296



L 740

43828 MATLOCK

spot; steel, wood, grey, black
Spot; Stahl, Holz, grau, schwarz
spot; acier, bois, gris, noir

L 520, B 145, H 225



E27 2x 40W



9 002759 438289



L 520

43827 MATLOCK

spot; steel, grey, black
Spot; Stahl, grau, schwarz
spot; acier, gris, noir

L 245, B 145, H 225



E27 1x 40W



9 002759 438272



L 245



43843

43843 MATLOCK

wall light; steel, grey, black
Wandleuchte; Stahl, grau, schwarz
Applique; acier, gris, noir

L 200, H 250, A 800



E27



1x 40W



9 002759 438432





JAPANDI

#PEACE
#ROOTS

Japanese interior style is characterized primarily by minimalism, with natural materials and colors. The roots of this trend reach far into the past and are based on long tradition. Craftsmanship has always been appreciated. The popularity of the style led to its combination with other trends, such as Scandinavian design, in recent years. In summary, peaceful simplicity, balance and the natural beauty count.

Der japanische Einrichtungsstil ist vor allem durch Minimalismus, natürliche Materialien und Farben gekennzeichnet. Die Wurzeln dieses Trends reichen weit in die Vergangenheit zurück und beruhen auf einer langen Tradition. Handwerkliches Können wurde schon immer geschätzt. Die Beliebtheit des Stils führte in den letzten Jahren zu seiner Kombination mit anderen Trends, wie dem skandinavischen Design. Zusammenfassend lässt sich sagen, dass friedliche Einfachheit, Ausgewogenheit und die natürliche Schönheit zählen.

Le style d'intérieur japonais se caractérise principalement par le minimalisme, avec des matériaux et des couleurs naturels. Les racines de cette tendance remontent loin dans le passé et reposent sur une longue tradition. Le savoir-faire artisanal a toujours été apprécié. La popularité de ce style a conduit à sa combinaison avec d'autres tendances, comme le design scandinave, ces dernières années. En résumé, la simplicité paisible, l'équilibre et la beauté naturelle comptent.



MIDSUMER
182-183



OXPARK
184-185



BUTTERBURN
186-187



BELGRAVE
188



MINTING
191



SUMMERHILL
192-194



ASBY
195



DOLWEN
196-197



BARLSTON
198-199



ALSAGER
200-201



This product is available in different colors and shapes./ Dieser Artikel ist in unterschiedlichen Farben und Formen verfügbar.
Cet article est disponible en différentes couleurs et formes.



43998



44002



44001

43998 MIDSUMER

ceiling light; steel, black / fabric, cream
Deckenleuchte; Stahl, schwarz / Textil, creme
plafonnier; acier, noir / tissu, crème

H 175, Ø 380



E27



1x 40W



9 002759 439989



44002 MIDSUMER

table light; steel, black / fabric, cream
Tischleuchte; Stahl, schwarz / Textil, creme
luminaire de table; acier, noir / tissu, crème

H 440, Ø 380, Base: Ø 200



E27



1x 40W



9 002759 440022

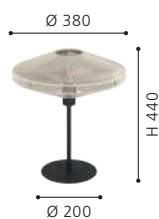

44001 MIDSUMER

pendant light; steel, black / fabric, cream
Hängeleuchte; Stahl, schwarz / Textil, creme
luminaire en suspension; acier, noir / tissu, crème

L 920, B 220, H 1100



E27



3x 40W



9 002759 440015





43999

43999 MIDSUMER

pendant light; steel, black / fabric, cream
Hängeleuchte; Stahl, schwarz / Textil, creme
luminaire en suspension; acier, noir / tissu, crème

H 1100, Ø 380



E27



1x 40W



9 002759 439996

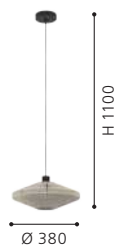



PURE

COLLECTION



43943

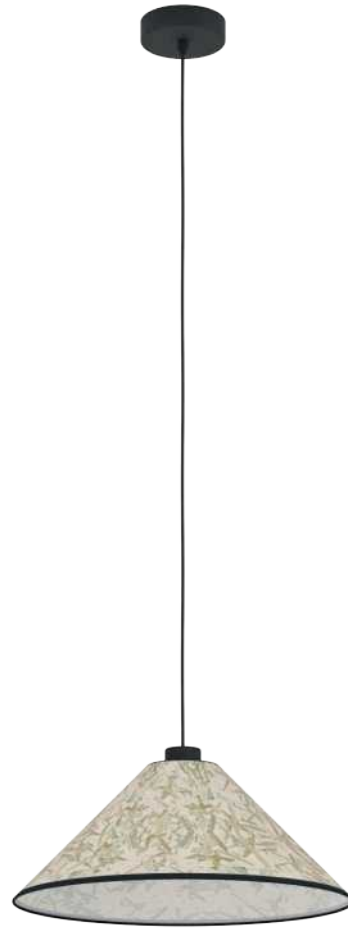

43942



43941

43943 OXPARK

pendant light; steel, black / fabric with bamboo leaves, white, green

Hängeleuchte; Stahl, schwarz / Textil mit Bambusblättern, weiss, grün

luminaire en suspension; acier, noir / tissu avec des feuilles de bam, blanc, vert

L 920, B 220, H 1100



E27



3x 25W



9 002759 439439



43942 OXPARK

pendant light; steel, black / fabric with bamboo leaves, white, green

Hängeleuchte; Stahl, schwarz / Textil mit Bambusblättern, weiss, grün

luminaire en suspension; acier, noir / tissu avec des feuilles de bam, blanc, vert

H 1100, Ø 420



E27



1x 25W



9 002759 439422



43941 OXPARK

ceiling light; steel, black / fabric with bamboo leaves, white, green

Deckenleuchte; Stahl, schwarz / Textil mit Bambusblättern, weiss, grün

plafonnier; acier, noir / tissu avec des feuilles de bam, blanc, vert

H 195, Ø 420



E27



1x 25W



9 002759 439415

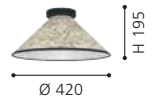



43944

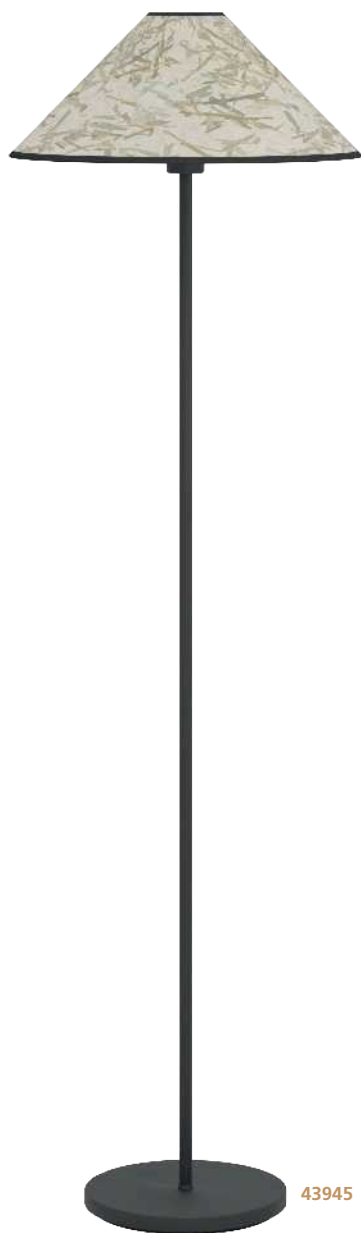

43945

DESIGN
HIGHLIGHT
DETAIL



DETAIL OXPARK

Dried bamboo leaves on flax fleece - a piece of nature for your own four walls.

Getrocknete Bambusblätter auf Flax Fleece - ein Stück Natur für Ihre eigenen vier Wände.

Des feuilles de bambou séchées sur un voile de lin - un morceau de nature pour vos propres murs.

43944 OXPARK

table light; steel, black / fabric with bamboo leaves, white, green

Tischleuchte; Stahl, schwarz / Textil mit Bambusblättern, weiss, grün

luminaire de table; acier, noir / tissu avec des feuilles de bam, blanc, vert

H 415, Ø 220, Base: Ø 145



E27



1x 25W



9 002759 439446

Ø 220



H 415



Ø 145

43945 OXPARK

floor light; steel, black / fabric with bamboo leaves, white, green

Stehleuchte; Stahl, schwarz / Textil mit Bambusblättern, weiss, grün

lampadaire; acier, noir / tissu avec des feuilles de bam, blanc, vert

H 1465, Ø 420, Base: Ø 250



E27



1x 25W



9 002759 439453

Ø 420



H 1465



Ø 250



PURE
COLLECTION



43939



43935



43938

43939 BUTTERBURN

floor light; steel, black / fabric with birch leaves, beige, green
Stehleuchte; Stahl, schwarz / Textil mit Birkenblättern, beige, grün
lampadaire; acier, noir / tissu avec des feuilles de bou, beige, vert

H 1620, Ø 360, Base: Ø 320



E27 1x 25W



9 002759 439392

43938 BUTTERBURN

table light; steel, black / fabric with birch leaves, beige, green
Tischleuchte; Stahl, schwarz / Textil mit Birkenblättern, beige, grün
luminaire de table; acier, noir / tissu avec des feuilles de bou, beige, vert

H 475, Ø 180, Base: Ø 180



E27 1x 25W



9 002759 439385

43935 BUTTERBURN

ceiling light; steel, black / fabric with birch leaves, beige, green
Deckenleuchte; Stahl, schwarz / Textil mit Birkenblättern, beige, grün
plafonnier; acier, noir / tissu avec des feuilles de bou, beige, vert

H 235, Ø 380



E27 1x 25W

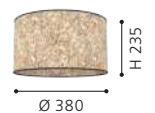

9 002759 439354

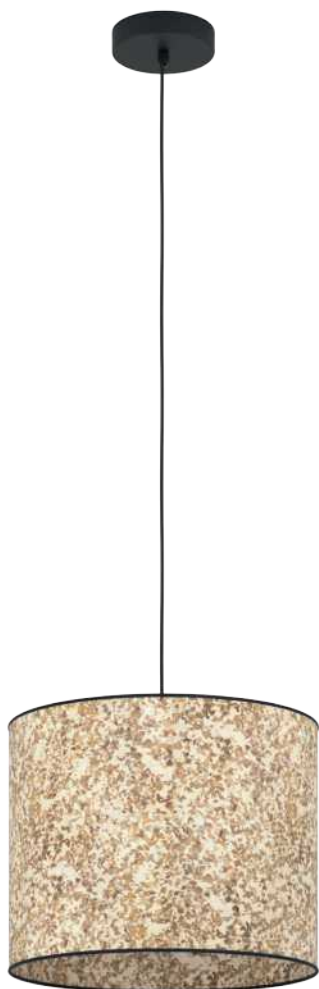

43936



43937

43936 BUTTERBURN

pendant light; steel, black / fabric with birch leaves, beige, green

Hängeleuchte; Stahl, schwarz / Textil mit Birkenblättern, beige, grün

luminaire en suspension; acier, noir / tissu avec des feuilles de bou, beige, vert

H 1100, Ø 360



E27



1x 25W



9 002759 439361



43937 BUTTERBURN

pendant light; steel, black / fabric with birch leaves, beige, green

Hängeleuchte; Stahl, schwarz / Textil mit Birkenblättern, beige, grün

luminaire en suspension; acier, noir / tissu avec des feuilles de bou, beige, vert

L 860, B 180, H 1100



E27



3x 25W



9 002759 439378



DESIGN
HIGHLIGHT
DETAIL

DETAIL BUTTERBURN

Dried birch leaves on flax fleece - a piece of nature for your own four walls.

Getrocknete Birkenblätter auf Flachsvlies - ein Stück Natur für Ihre eigenen vier Wände.

Feuilles de bouleau séchées sur voile de lin - un peu de nature pour vos propres murs.



44103

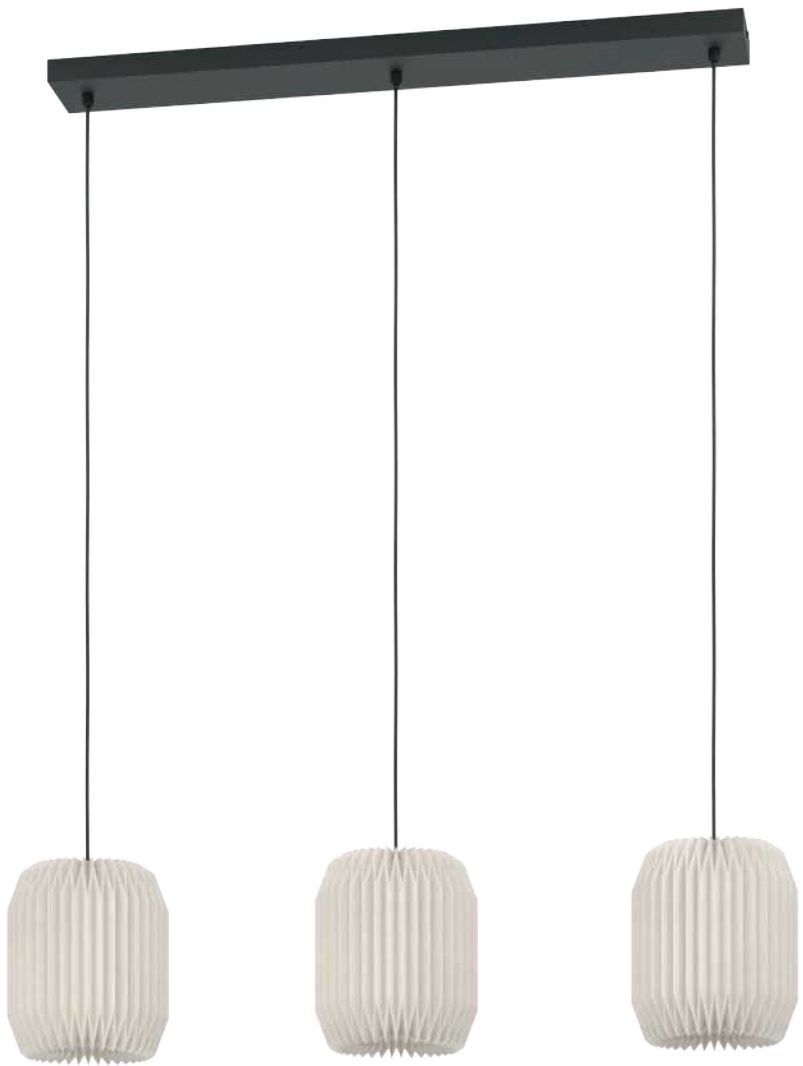

44102



44103 BELGRAVE

table light; steel, black / paper, white
Tischleuchte; Stahl, schwarz / Papier, weiss
luminaire de table; acier, noir / papier, blanc

H 440, Ø 180, Base: Ø 220



E27 1x 40W



9 002759 441036



44102 BELGRAVE

pendant light; steel, black / paper, white
Hängeleuchte; Stahl, schwarz / Papier, weiss
luminaire en suspension; acier, noir / papier, blanc

L 880, B 180, H 1100



E27 3x 40W



9 002759 441029



44104 BELGRAVE

floor light; steel, black / paper, white
Stehleuchte; Stahl, schwarz / Papier, weiss
lampadaire; acier, noir / papier, blanc

H 1415, Ø 300, Base: Ø 720

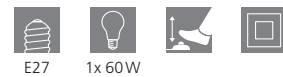

E27 1x 60W



9 002759 441043



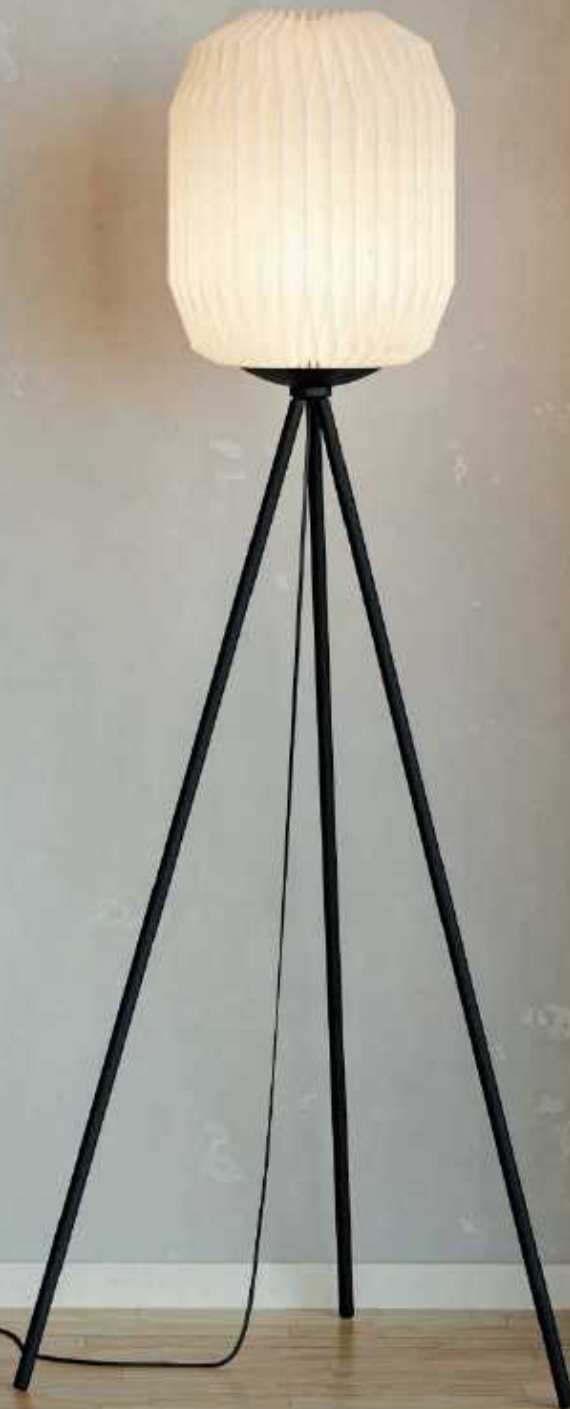

44104





43933



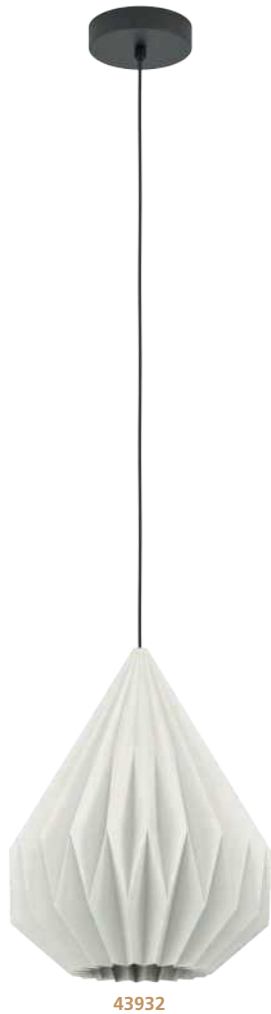

43932

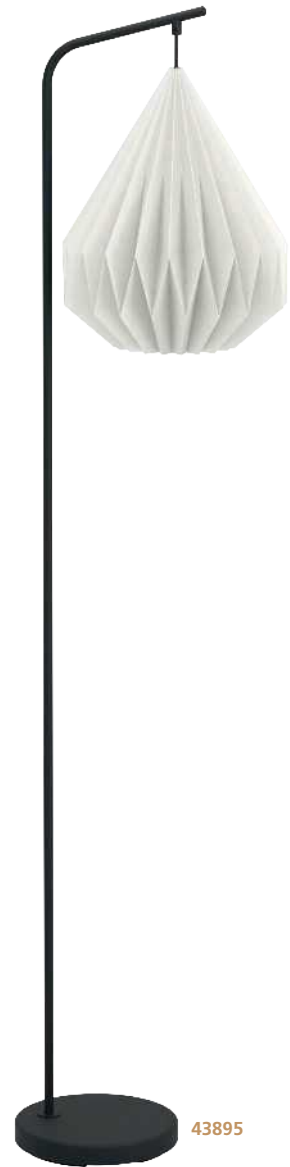

43895

43933 MINTING

pendant light; steel, black / paper, white
 Hängeleuchte; Stahl, schwarz / Papier, weiss
 luminaire en suspension; acier, noir / papier, blanc

H 1100, Ø 450



E27



1x 25W



9 002759 439330



43932 MINTING

pendant light; steel, black / paper, white
 Hängeleuchte; Stahl, schwarz / Papier, weiss
 luminaire en suspension; acier, noir / papier, blanc

H 1100, Ø 310



E27



1x 25W



9 002759 439323



43895 MINTING

floor light; steel, black / paper, white
 Stehleuchte; Stahl, schwarz / Papier, weiss
 lampadaire; acier, noir / papier, blanc

L 365, B 300, H 1585, Base: Ø 230



E27



1x 25W



9 002759 438951

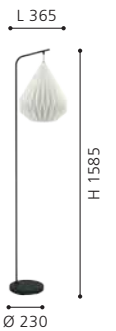



44063



DESIGN
HIGHLIGHT
DETAIL



44064



44063 SUMMERHILL

ceiling light; wood, steel, brown / paper, white
Deckenleuchte; Holz, Stahl, braun / Papier, weiss
plafonnier; bois, acier, marron / papier, blanc

H 245, Ø 400



E27 1x 40W



9 002759 440633



44064 SUMMERHILL

pendant light; steel, wood, white, brown / paper, white
Hängeleuchte; Stahl, Holz, weiss, braun / Papier, weiss
luminaire en suspension; acier, bois, blanc, marron / papier, blanc

H 1100, Ø 400



E27 1x 40W



9 002759 440640



44065 SUMMERHILL

pendant light; steel, wood, white, brown / paper, white
Hängeleuchte; Stahl, Holz, weiss, braun / Papier, weiss
luminaire en suspension; acier, bois, blanc, marron / papier, blanc

H 1100, Ø 550



E27 1x 40W



9 002759 440657





44065





44066



44067



44066 SUMMERHILL

pendant light; steel, wood, white, brown / paper, white
 Hängeleuchte; Stahl, Holz, weiss, braun / Papier, weiss
 luminaire en suspension; acier, bois, blanc, marron / papier, blanc

L 925, B 225, H 1100



E27



3x 40W



9 002759 440664

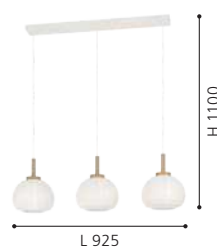

44067 SUMMERHILL

table light; wood, steel, brown / paper, white
 Tischleuchte; Holz, Stahl, braun / Papier, weiss
 luminaire de table; bois, acier, marron / papier, blanc

H 200, Ø 225, Base: Ø 100



E27



1x 40W



9 002759 440671





44014



44015



44014 ASBY

table light; wood, light brown
Tischleuchte; Holz, hellbraun
luminaire de table; bois, marron clair

H 100, Ø 85



E27



1x 40W



9 002759 440145



Ø 85

H 100

44015 ASBY

table light; wood, dark brown
Tischleuchte; Holz, dunkelbraun
luminaire de table; bois, marron foncé

H 100, Ø 85



E27



1x 40W



9 002759 440152



Ø 85

H 100

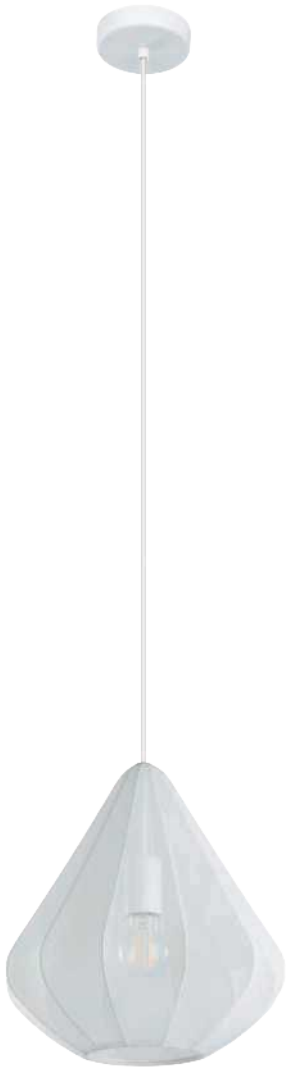

43996

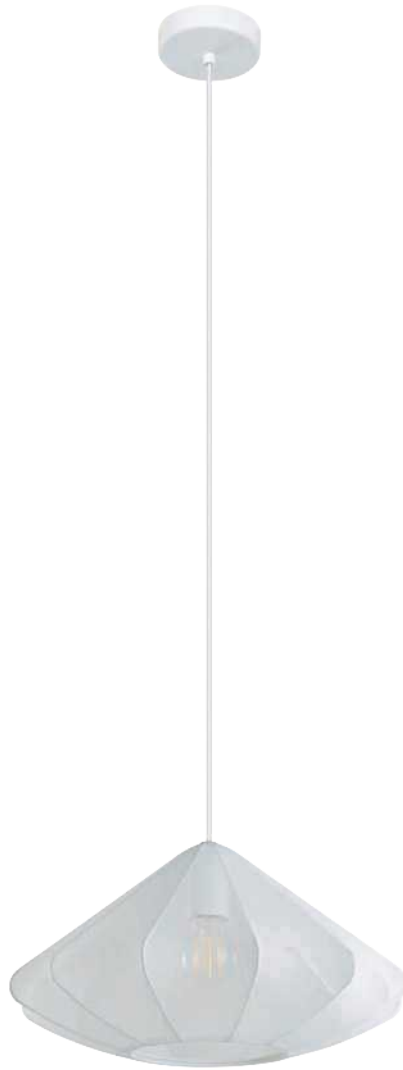

43997

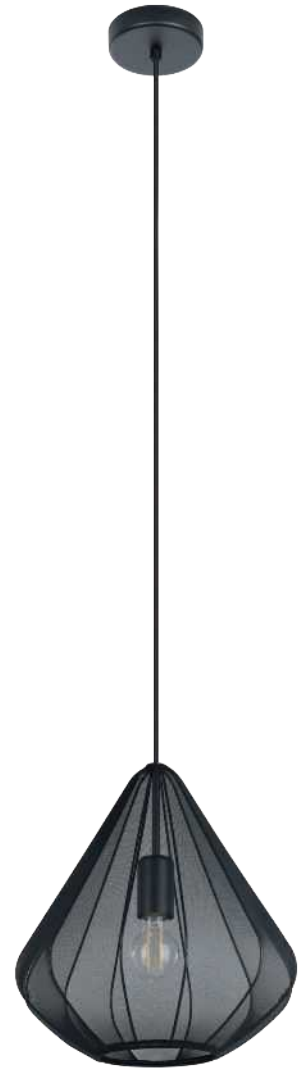

43994

43996 DOLWEN

pendant light; steel, white / fabric, white
 Hängeleuchte; Stahl, weiss / Textil, weiss
 luminaire en suspension; acier, blanc / tissu, blanc

H 1100, Ø 335



E27 1x 40W



9 002759 439965



43997 DOLWEN

pendant light; steel, white / fabric, white
 Hängeleuchte; Stahl, weiss / Textil, weiss
 luminaire en suspension; acier, blanc / tissu, blanc

H 1100, Ø 425



E27 1x 40W



9 002759 439972



43994 DOLWEN

pendant light; steel, black / fabric, black
 Hängeleuchte; Stahl, schwarz / Textil, schwarz
 luminaire en suspension; acier, noir / tissu, noir

H 1100, Ø 335



E27 1x 40W



9 002759 439941

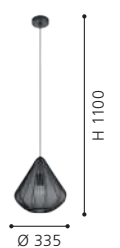



43995

43995 DOLWEN

pendant light; steel, black / fabric, black
Hängeleuchte; Stahl, schwarz / Textil, schwarz
luminaire en suspension; acier, noir / tissu, noir

H 1100, Ø 425



E27



1x 40W



9 002759 439958

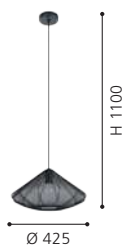



43961

43961 BARLASTON

pendant light; steel, black / fabric, grey
Hängeleuchte; Stahl, schwarz / Textil, grau
luminaire en suspension; acier, noir / tissu, gris

H 1100, Ø 450



E27



1x 40W



DESIGN
HIGHLIGHT
DETAIL



9 002759 439613

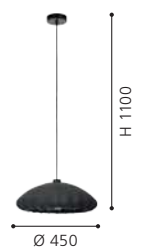



43962



43973

43946

43962 BARLASTON

pendant light; steel, black / fabric, grey
 Hängeleuchte; Stahl, schwarz / Textil, grau
 luminaire en suspension; acier, noir / tissu, gris

L 880, B 180, H 1100



E27



3x 40W



9 002759 439620



L 880

H 1100

43946 BARLASTON

table light; steel, black / fabric, grey
 Tischleuchte; Stahl, schwarz / Textil, grau
 luminaire de table; acier, noir / tissu, gris

H 390, Ø 180, Base: Ø 120



E27



1x 40W



9 002759 439460



Ø 120

H 390

43973 BARLASTON

pendant light; steel, black / fabric, grey
 Hängeleuchte; Stahl, schwarz / Textil, grau
 luminaire en suspension; acier, noir / tissu, gris

H 1100, Ø 350



E27



1x 40W



9 002759 439736



Ø 350

H 1100

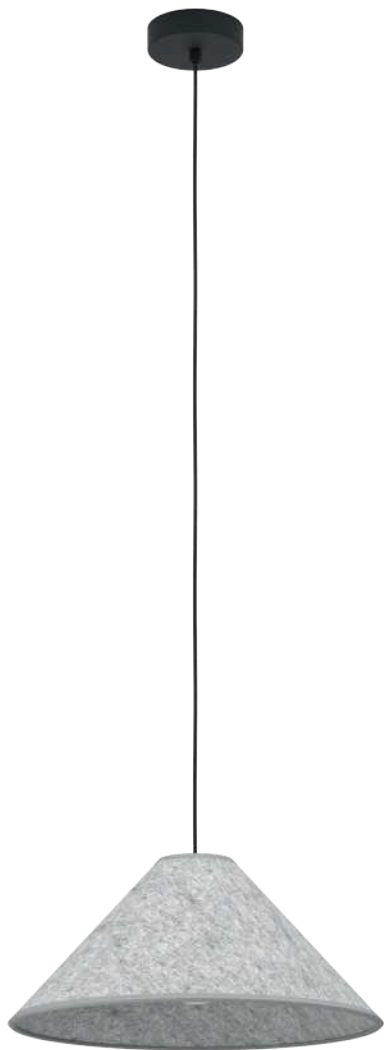

43984



43985

43984 ALSAGER

pendant light; steel, black / felt, grey
 Hängeleuchte; Stahl, schwarz / Filz, grau
 luminaire en suspension; acier, noir / feutre, gris

H 1100, Ø 410



E27 1x 40W



9 002759 439842

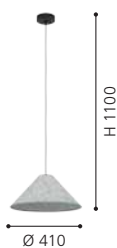

43985 ALSAGER

pendant light; steel, black / felt, grey
 Hängeleuchte; Stahl, schwarz / Filz, grau
 luminaire en suspension; acier, noir / feutre, gris

L 910, B 210, H 1100



E27 3x 40W



9 002759 439859



43987 ALSAGER

floor light; steel, black / felt, grey
 Stehleuchte; Stahl, schwarz / Filz, grau
 lampadaire; acier, noir / feutre, gris

L 505, B 210, H 1700, Base: Ø 300



E27 1x 40W



9 002759 439873

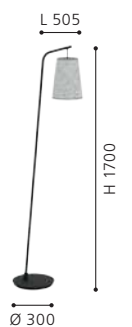



43987



43986

43986 ALSAGER

table light; steel, black / felt, grey
Tischleuchte; Stahl, schwarz / Filz, grau
luminaire de table; acier, noir / feutre, gris

H 395, Ø 200, Base: Ø 150



E27



1x 40W



9 002759 439866

Ø 200



H 395



Ø 150



! NATURE

#PURE
#GREEN

Bring the warmth and comfort of natural elements into your home. The back-to-nature trend incorporates designs that use natural materials, harmonious colour combinations, and simple, neutral shapes. A lamp from the EGLO Nature range will increase the comfort of any living space, no matter what interior design style you prefer.

Holen Sie sich pure Gemütlichkeit in Ihr zu Hause, ganz getreu dem Motto „back to nature“. Der Nature-Trend umfasst Designs mit natürlichen Materialien, aufeinander abgestimmten Farbkombinationen und neutralen sowie einfachen Formen. Egal welchen Einrichtungsstil Sie bevorzugen, mit einer EGLO Leuchte aus der Kategorie Nature steigern Sie das Wohlbefinden im Wohnraum.

Faites entrer le confort absolu dans votre maison, fidèle à la devise „retour à la nature“. La tendance nature comprend des designs avec des matériaux naturels, des combinaisons de couleurs coordonnées et des formes neutres et simples. Quel que soit le style d'ameublement que vous préférez, avec une lampe EGLO de la catégorie Nature, vous augmentez le bien-être dans le salon.



ALDERNEY 204 	ADWICKLE 205 	PERSLEY 206-207 	LAVISTER 208 	SIRUELA 210-211 	MARYWELL 212-213 	ANWICK 214-215 	ANWICK 1 216 		
HYKEHAM 218-219 	LEOMINSTER 219 	GLYNEATH 220 	LYDNEY 220 	BORDESLEY 222-223 	DEMBLEBY 224-225 	CLAVERDON 225 	AYESGARTH 226 		
AMSFIELD 227 	AMSFIELD 1 228 	KIRKCOLM 230 	AYCLIFFE 230 	HAXEY 230 	HETTONLE 231 	MEDJOUNA 232 	MARFORD 232 		
TABLEY 234-235 	ROSLEY 236-237 	SURFLEET 238 							



 This product is available in different colors and shapes./ Dieser Artikel ist in unterschiedlichen Farben und Formen verfügbar.
Cet article est disponible en différentes couleurs et formes.



43785



43784



43786

43785 ALDERNEY

pendant light; steel, black / textile thread, natural
Hängeleuchte; Stahl, schwarz / Textilfaden, natur
luminaire en suspension; acier, noir / fil textile, nature

H 1100, Ø 300



E27 1x 40W



9 002759 437855



43784 ALDERNEY

ceiling light; steel, black / textile thread, natural
Deckenleuchte; Stahl, schwarz / Textilfaden, natur
plafonnier; acier, noir / fil textile, nature

H 240, Ø 480



E27 1x 40W



9 002759 437848

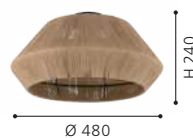

43786 ALDERNEY

pendant light; steel, black / textile thread, natural
Hängeleuchte; Stahl, schwarz / Textilfaden, natur
luminaire en suspension; acier, noir / fil textile, nature

L 900, B 200, H 1100



E27 3x 40W



9 002759 437862





43775

43777

43776

43775 ADWICKLE

ceiling light; steel, black / fabric, natural
 Deckenleuchte; Stahl, schwarz / Textil, natur
 plafonnier; acier, noir / tissu, nature

H 260, Ø 445



E27

1x 40W



9 002759 437756



Ø 445

H 260

43777 ADWICKLE

pendant light; steel, black / fabric, natural
 Hängeleuchte; Stahl, schwarz / Textil, natur
 luminaire en suspension; acier, noir / tissu, nature

L 870, B 145, H 1100



E27

3x 40W



9 002759 437770



L 870

H 1100

43776 ADWICKLE

pendant light; steel, black / fabric, natural
 Hängeleuchte; Stahl, schwarz / Textil, natur
 luminaire en suspension; acier, noir / tissu, nature

L 170, B 145, H 1100



E27

1x 40W



9 002759 437763



L 170

H 1100

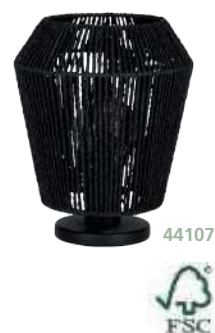

44105 PERSLEY

pendant light; steel, black / paper, black
 Hängeleuchte; Stahl, schwarz / Papier, schwarz
 luminaire en suspension; acier, noir / papier, noir

H 1100, Ø 220



44108 PERSLEY

floor light; steel, black / paper, black
 Stehleuchte; Stahl, schwarz / Papier, schwarz
 lampadaire; acier, noir / papier, noir

H 1555, Ø 220, Base: Ø 230

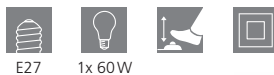

44107 PERSLEY

table light; steel, black / paper, black
 Tischleuchte; Stahl, schwarz / Papier, schwarz
 luminaire de table; acier, noir / papier, noir

H 275, Ø 220, Base: Ø 120

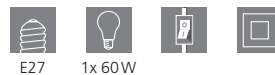



44106



44106 PERSLEY

pendant light; steel, black / paper, black
Hängeleuchte; Stahl, schwarz / Papier, schwarz
luminaire en suspension; acier, noir / papier, noir

L 920, B 220, H 1100



E27



3x 60W



9 002759 441067





44072



44073



44072 LAVISTER

pendant light; steel, black / paper, natural
Hängeleuchte; Stahl, schwarz / Papier, natur
luminaire en suspension; acier, noir / papier, nature

H 1100, Ø 390



E27 1x 60W



9 002759 440725



44073 LAVISTER

pendant light; steel, black / paper, natural
Hängeleuchte; Stahl, schwarz / Papier, natur
luminaire en suspension; acier, noir / papier, nature

L 910, B 210, H 1100



E27 3x 60W



9 002759 440732



44071 LAVISTER

ceiling light; steel, black / paper, natural
Deckenleuchte; Stahl, schwarz / Papier, natur
plafonnier; acier, noir / papier, nature

H 175, Ø 390



E27 1x 60W



9 002759 440718





44071





31966



31964



31965



31966 SIRUELA

floor light; steel, black / paper, natural
Stehleuchte; Stahl, schwarz / Papier, natur
lampadaire; acier, noir / papier, nature

L 480, B 560, H 1600, Base: Ø 230



E27

1x 42W

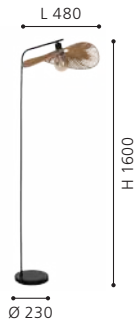

9 002759 319663

31964 SIRUELA

wall light; steel, black / paper, natural
Wandleuchte; Stahl, schwarz / Papier, natur
Applique; acier, noir / papier, nature

L 365, H 250, A 350



E27

1x 42W

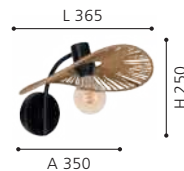

9 002759 319649

31965 SIRUELA

table light; steel, black / paper, natural
Tischleuchte; Stahl, schwarz / Papier, natur
luminaire de table; acier, noir / papier, nature

L 320, B 365, H 465, Base: Ø 180



E27

1x 42W



9 002759 319656



31991 SIRUELA

pendant light; steel, black / paper, natural
 Hängeleuchte; Stahl, schwarz / Papier, natur
 luminaire en suspension; acier, noir / papier, nature

L 560, B 400, H 1100

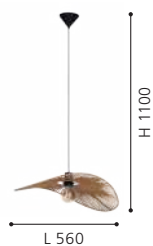

31992 SIRUELA

pendant light; steel, black / paper, natural
 Hängeleuchte; Stahl, schwarz / Papier, natur
 luminaire en suspension; acier, noir / papier, nature

L 800, B 600, H 1100



31961 SIRUELA

ceiling light; steel, black / paper, natural
 Deckenleuchte; Stahl, schwarz / Papier, natur
 plafonnier; acier, noir / papier, nature

L 560, B 400, H 160





44044



44045



44043

44044 MARYWELL

pendant light; steel, black / wood, brown
 Hängeleuchte; Stahl, schwarz / Holz, braun
 luminaire en suspension; acier, noir / bois, marron

L 500, B 345, H 1100



E27 1x 40W



9 002759 440442



44045 MARYWELL

wall light; steel, black / wood, brown
 Wandleuchte; Stahl, schwarz / Holz, braun
 Applique; acier, noir / bois, marron

L 200, H 300, A 115



E27 1x 40W



9 002759 440459



44043 MARYWELL

ceiling light; steel, black / wood, brown
 Deckenleuchte; Stahl, schwarz / Holz, braun
 plafonnier; acier, noir / bois, marron

L 500, B 345, H 165



E27 1x 40W



9 002759 440435

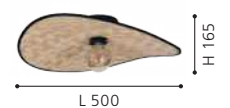

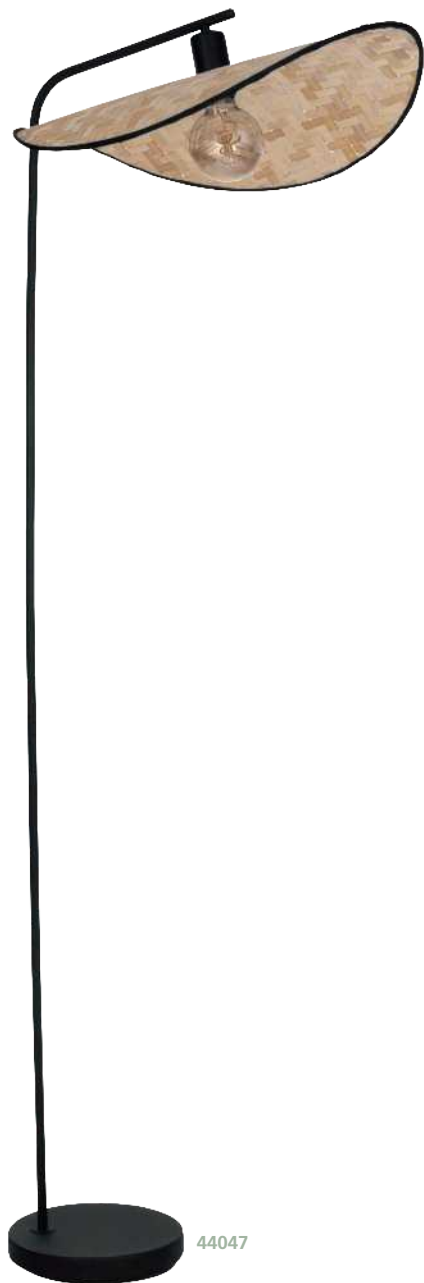

44047



44046

44047 MARYWELL

floor light; steel, black / wood, brown
 Stehleuchte; Stahl, schwarz / Holz, braun
 lampadaire; acier, noir / bois, marron

L 555, B 345, H 1595, Base: Ø 230



E27 1x 40W

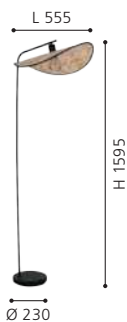

9 002759 440473

44046 MARYWELL

table light; steel, black / wood, brown
 Tischleuchte; Stahl, schwarz / Holz, braun
 luminaire de table; acier, noir / bois, marron

L 290, B 300, H 465, Base: Ø 180



E27 1x 40W



9 002759 440466

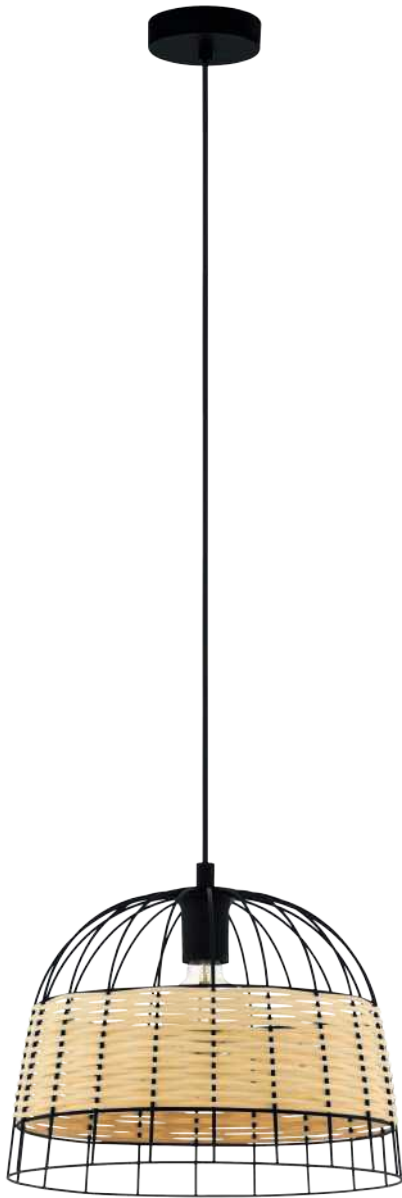

43311



43313

43311 ANWICK

pendant light; steel, black / rattan, natural
 Hängeleuchte; Stahl, schwarz / Rattan, natur
 luminaire en suspension; acier, noir / rotin, nature

H 1100, Ø 370



E27



1x 40W



9 002759 433116



43313 ANWICK

pendant light; steel, black / rattan, natural
 Hängeleuchte; Stahl, schwarz / Rattan, natur
 luminaire en suspension; acier, noir / rotin, nature

L 880, B 180, H 1100



E27



3x 40W



9 002759 433130





43398



43312



43398 ANWICK

ceiling light; steel, black / rattan, natural
Deckenleuchte; Stahl, schwarz / Rattan, natur
plafonnier; acier, noir / rotin, nature

H 265, Ø 380



E27



1x 60W



9 002759 433987

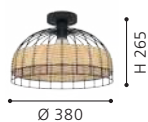

43312 ANWICK

pendant light; steel, black / rattan, natural
Hängeleuchte; Stahl, schwarz / Rattan, natur
luminaire en suspension; acier, noir / rotin, nature

H 1100, Ø 500



E27



1x 40W



9 002759 433123





43325



43326

43325 ANWICK 1

spot; steel, black / rattan, natural
Spot; Stahl, schwarz / Rattan, natur
spot; acier, noir / rotin, nature

L 480, B 140, H 240



E27



2x 40W



9 002759 433253

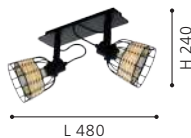

L 480

H 240

43326 ANWICK 1

spot; steel, black / rattan, natural
Spot; Stahl, schwarz / Rattan, natur
spot; acier, noir / rotin, nature

L 670, B 140, H 240



E27



3x 40W



9 002759 433260



L 670

H 240

43324 ANWICK 1

spot; steel, black / rattan, natural
Spot; Stahl, schwarz / Rattan, natur
spot; acier, noir / rotin, nature

L 140, H 200



E27



1x 40W



9 002759 433246



L 140

H 200



43324





43851



43854



43853

43851 HYKEHAM

ceiling light; steel, black / wood, natural
Deckenleuchte; Stahl, schwarz / Holz, natur
plafonnier; acier, noir / bois, nature

H 210, Ø 380



E27 1x 40W



9 002759 438517

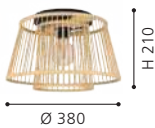

43854 HYKEHAM

table light; steel, black / wood, natural
Tischleuchte; Stahl, schwarz / Holz, natur
luminaire de table; acier, noir / bois, nature

H 570, Ø 210, Base: Ø 285



E27 1x 40W



9 002759 438548



43853 HYKEHAM

pendant light; steel, black / wood, natural
Hängeleuchte; Stahl, schwarz / Holz, natur
luminaire en suspension; acier, noir / bois, nature

L 910, B 210, H 1100



E27 3x 40W



9 002759 438531



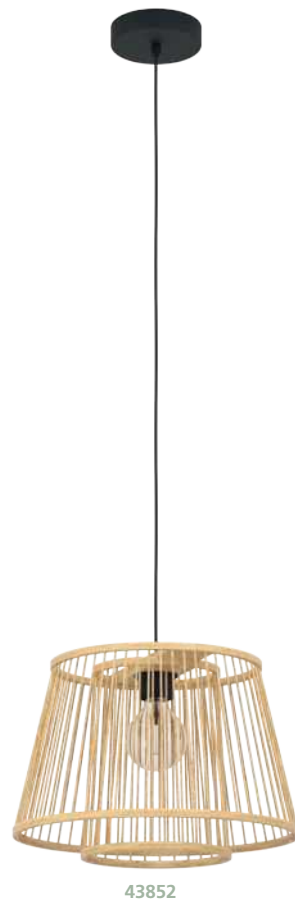

43855 HYKEHAM

floor light; steel, black / wood, natural
 Stehleuchte; Stahl, schwarz / Holz, natur
 lampadaire; acier, noir / bois, nature

H 1295, Ø 380, Base: Ø 630



E27 1x 40W



9 002759 438555

43852 HYKEHAM

pendant light; steel, black / wood, natural
 Hängeleuchte; Stahl, schwarz / Holz, natur
 luminaire en suspension; acier, noir / bois, nature

H 1100, Ø 380



E27 1x 40W



9 002759 438524

43883 LEOMINSTER

wall/ceiling light; steel, black / wood, natural
 Wand- / Deckenleuchte; Stahl, schwarz / Holz, natur
 Applique/Plafonnier; acier, noir / bois, nature

H 90, Ø 450



E27 1x 40W

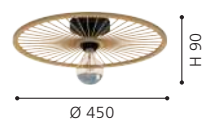

9 002759 438838



43872



DESIGN
HIGHLIGHT
DETAIL

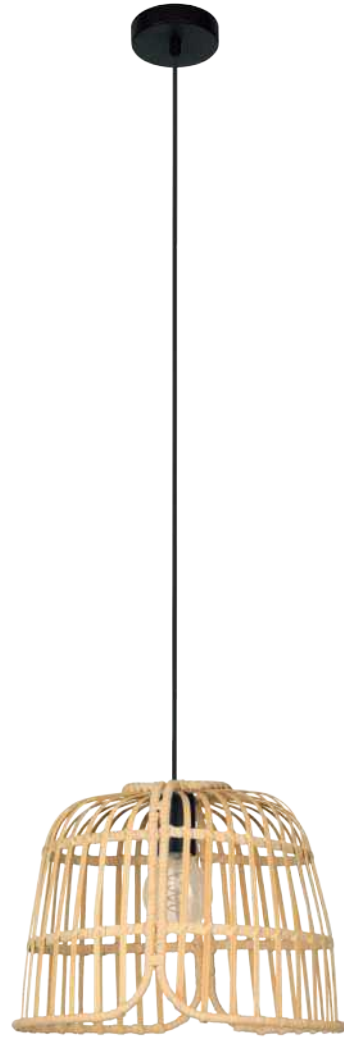

43873

43872 GLYNEATH

ceiling light; steel, black / wood, natural
Deckenleuchte; Stahl, schwarz / Holz, natur
plafonnier; acier, noir / bois, nature

H 205, Ø 375



E27 1x 40W



9 002759 438722



43873 GLYNEATH

pendant light; steel, black / wood, natural
Hängeleuchte; Stahl, schwarz / Holz, natur
luminaire en suspension; acier, noir / bois, nature

H 1100, Ø 375



E27 1x 40W



9 002759 438739



44012 LYDNEY

pendant light; steel, black / wood, brown
Hängeleuchte; Stahl, schwarz / Holz, braun
luminaire en suspension; acier, noir / bois, marron

H 1100, Ø 570



E27 1x 40W



9 002759 440121

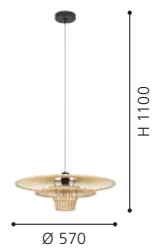



44012



43216

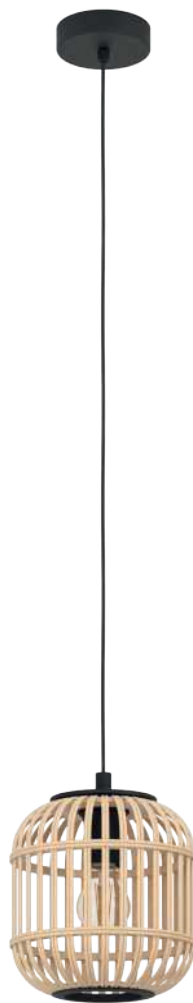

43231



43218

43216 BORDESLEY

pendant light; steel, black / wood, natural
Hängeleuchte; Stahl, schwarz / Holz, natur
luminaire en suspension; acier, noir / bois, nature

H 1100, Ø 350



E27 1x 28W



9 002759 432164



43231 BORDESLEY

pendant light; steel, black / wood, natural
Hängeleuchte; Stahl, schwarz / Holz, natur
luminaire en suspension; acier, noir / bois, nature

H 1100, Ø 210



E27 1x 28W



9 002759 432317



43218 BORDESLEY

table light; steel, black / wood, natural
Tischleuchte; Stahl, schwarz / Holz, natur
luminaire de table; acier, noir / bois, nature

H 400, Ø 210, Base: Ø 190



E27 1x 28W



9 002759 432188





43217



43219

43217 BORDESLEY

pendant light; steel, black / wood, natural
Hängeleuchte; Stahl, schwarz / Holz, natur
luminaire en suspension; acier, noir / bois, nature

L 910, B 210, H 1100



E27



3x 28W



9 002759 432171



43219 BORDESLEY

floor light; steel, black / wood, natural
Stehleuchte; Stahl, schwarz / Holz, natur
lampadaire; acier, noir / bois, nature

H 1390, Ø 350, Base: Ø 560



E27



1x 28W



9 002759 432195





43262



43263

43262 DEMBLEBY

pendant light; steel, black / wood, natural
 Hängeleuchte; Stahl, schwarz / Holz, natur
 luminaire en suspension; acier, noir / bois, nature

L 900, B 200, H 1100



E27



3x 40W



9 002759 432621



43263 DEMBLEBY

table light; steel, black / wood, natural
 Tischleuchte; Stahl, schwarz / Holz, natur
 luminaire de table; acier, noir / bois, nature

H 250, Ø 200, Base: Ø 115



E27



1x 40W



9 002759 432638



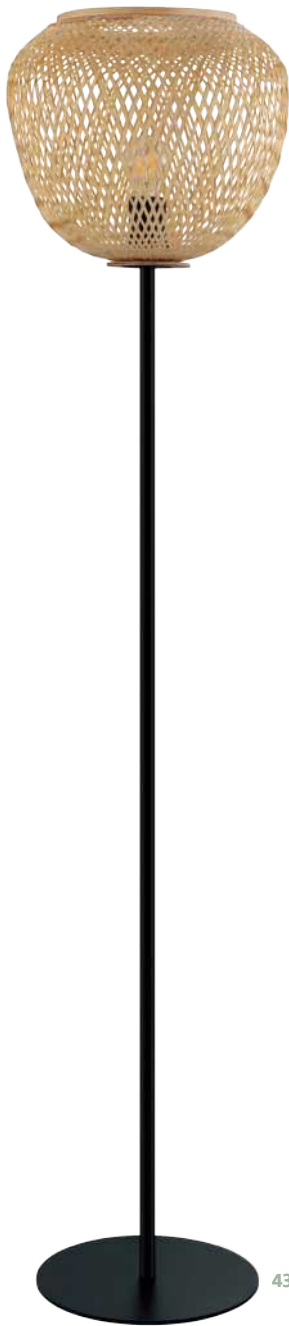

43264

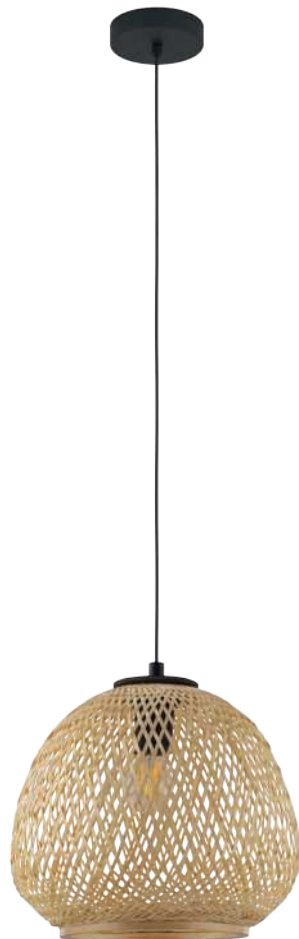

43261

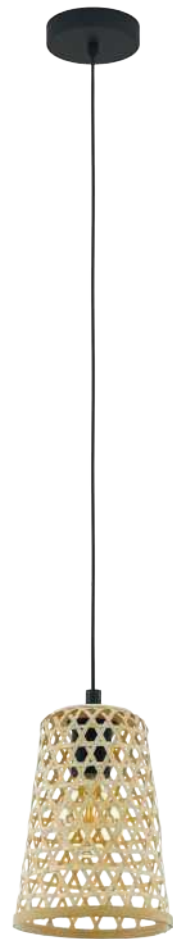

43252

43264 DEMBLEBY

floor light; steel, black / wood, natural
Stehleuchte; Stahl, schwarz / Holz, natur
lampadaire; acier, noir / bois, nature

H 1500, Ø 320, Base: Ø 275



E27 1x 40W

Ø 320



H 1500

Ø 275



9 002759 432645

43261 DEMBLEBY

pendant light; steel, black / wood, natural
Hängeleuchte; Stahl, schwarz / Holz, natur
luminaire en suspension; acier, noir / bois, nature

H 1100, Ø 320



E27 1x 40W

H 1100

Ø 320



9 002759 432614

43252 CLAVERDON

pendant light; steel, black / wood, natural
Hängeleuchte; Stahl, schwarz / Holz, natur
luminaire en suspension; acier, noir / bois, nature

H 1100, Ø 180



E27 1x 40W

H 1100

Ø 180



9 002759 432522



43866



43867

43866 AYESGARTH

pendant light; steel, black / wood, natural
Hängeleuchte; Stahl, schwarz / Holz, natur
luminaire en suspension; acier, noir / bois, nature

H 1100, Ø 330



E27



1x 40W



9 002759 438661



43867 AYESGARTH

pendant light; steel, black / wood, natural
Hängeleuchte; Stahl, schwarz / Holz, natur
luminaire en suspension; acier, noir / bois, nature

L 910, B 210, H 1100



E27



3x 40W



9 002759 438678





49772



43723



49771

49772 AMSFIELD

pendant light; steel, brown / wood, brown
 Hängeleuchte; Stahl, braun / Holz, braun
 luminaire en suspension; acier, marron / bois, marron

H 1100, Ø 350



E27



1x 60W



9 002759 497729



43723 AMSFIELD

ceiling light; steel, black / wood, brown
 Deckenleuchte; Stahl, schwarz / Holz, braun
 plafonnier; acier, noir / bois, marron

H 285, Ø 450



E27



1x 40W



9 002759 437237

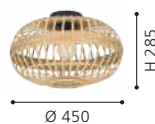

49771 AMSFIELD

pendant light; steel, brown / wood, brown
 Hängeleuchte; Stahl, braun / Holz, braun
 luminaire en suspension; acier, marron / bois, marron

H 1100, Ø 380



E27



1x 60W



9 002759 497712





43863



43864

43863 AMSFIELD 1

pendant light; steel, black / wood, natural
 Hängeleuchte; Stahl, schwarz / Holz, natur
 luminaire en suspension; acier, noir / bois, nature

L 960, B 260, H 1100



E27 3x 40W



9 002759 438630

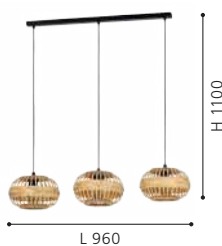

43864 AMSFIELD 1

pendant light; steel, black / wood, natural
 Hängeleuchte; Stahl, schwarz / Holz, natur
 luminaire en suspension; acier, noir / bois, nature

H 1100, Ø 480



E27 3x 40W



9 002759 438647



43865 AMSFIELD 1

table light; steel, black / wood, natural
 Tischleuchte; Stahl, schwarz / Holz, natur
 luminaire de table; acier, noir / bois, nature

H 410, Ø 260, Base: Ø 200



E27 1x 40W



9 002759 438654





43865

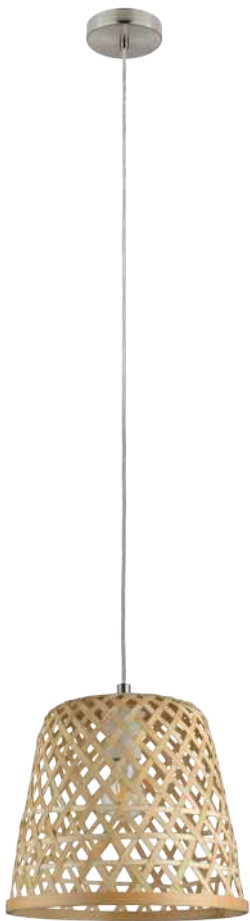

43113

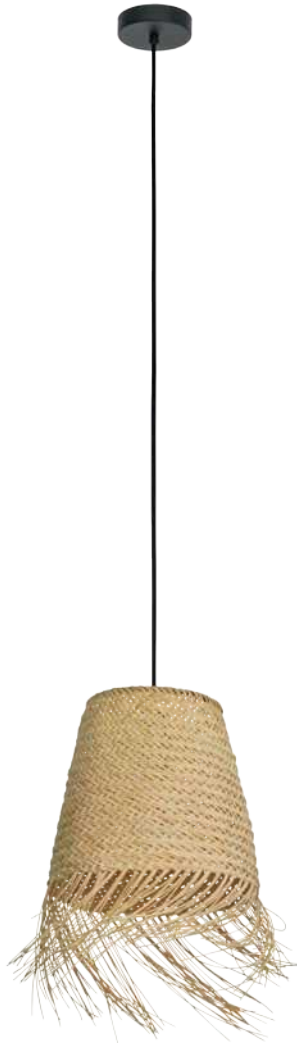

43871

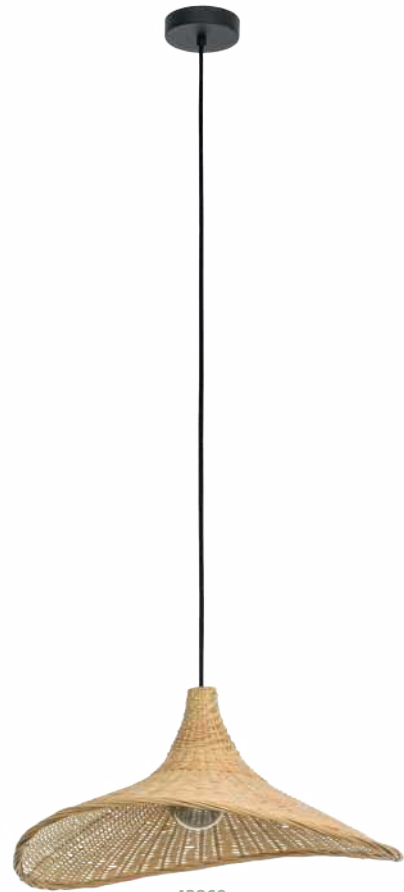

43869

43113 KIRKCOLM

pendant light; steel, satin nickel / wood, natural
 Hängeleuchte; Stahl, nickel-matt / Holz, natur
 luminaire en suspension; acier, nickel mat / bois, nature

H 1100, Ø 300



E27 1x 60W



9 002759 431136



43871 AYCLIFFE

pendant light; steel, black / wood, natural
 Hängeleuchte; Stahl, schwarz / Holz, natur
 luminaire en suspension; acier, noir / bois, nature

H 1100, Ø 300



E27 1x 40W



9 002759 438715



43869 HAXEY

pendant light; steel, black / wood, natural
 Hängeleuchte; Stahl, schwarz / Holz, natur
 luminaire en suspension; acier, noir / bois, nature

H 1100, Ø 500



E27 1x 40W



9 002759 438692

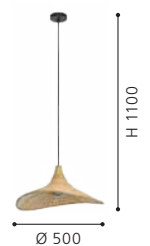



43868

43868 HETTONLE

pendant light; steel, black / wood, natural
Hängeleuchte; Stahl, schwarz / Holz, natur
luminaire en suspension; acier, noir / bois, nature

H 1100, Ø 420



E27



1x 40W



9 002759 438685

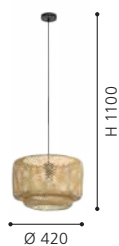

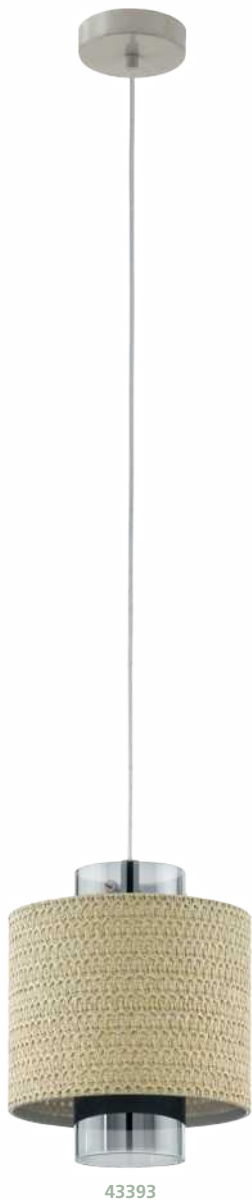

43393



44095



43393 MEDIUMA

pendant light; steel, beige / glass vaporized, seagrass, matte grey

Hängeleuchte; Stahl, beige / Glas bedampft, Seegrass, goldfarben, braun

luminaire en suspension; acier, beige / Verre vaporisé, gazon, doré, marron
H 1100, Ø 230



E27 1x 40W



9 002759 433932

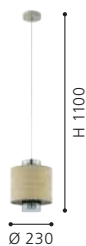

44095 MARFORD

ceiling light; steel, black / bast, natural
Deckenleuchte; Stahl, schwarz / Bast, natur
plafonnier; acier, noir / raphia, nature

H 190, Ø 500



E27 1x 60W



9 002759 440954



44096 MARFORD

pendant light; steel, black / bast, natural
Hängeleuchte; Stahl, schwarz / Bast, natur
luminaire en suspension; acier, noir / raphia, nature

H 1100, Ø 500



E27 1x 60W



9 002759 440961





44096



43974



43977



43978

43974 TABLEY

ceiling light; steel, black / fabric, wood, nature, brown
Deckenleuchte; Stahl, schwarz / Textil, Holz, natur, braun
plafonnier; acier, noir / tissu, bois, nature, marron

H 235, Ø 380



E27 1x 40W



9 002759 439743

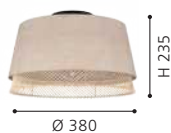

43977 TABLEY

table light; steel, black / fabric, wood, nature, brown
Tischleuchte; Stahl, schwarz / Textil, Holz, natur, braun
luminaire de table; acier, noir / tissu, bois, nature, marron

H 425, Ø 190, Base: Ø 145

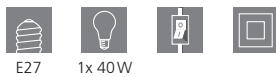

E27 1x 40W



9 002759 439774



43978 TABLEY

floor light; steel, black / fabric, wood, nature, brown
Stehleuchte; Stahl, schwarz / Textil, Holz, natur, braun
lampadaire; acier, noir / tissu, bois, nature, marron

H 1530, Ø 380, Base: Ø 250



E27 1x 40W



9 002759 439781





43976



43975

43976 TABLEY

pendant light; steel, black / fabric, wood, nature, brown
 Hängeleuchte; Stahl, schwarz / Textil, Holz, natur, braun
 luminaire en suspension; acier, noir / tissu, bois, nature, marron

L 890, B 190, H 1100



E27



3x 40W



9 002759 439767



H 1100

L 890

43975 TABLEY

pendant light; steel, black / fabric, wood, nature, brown
 Hängeleuchte; Stahl, schwarz / Textil, Holz, natur, braun
 luminaire en suspension; acier, noir / tissu, bois, nature, marron

H 1100, Ø 380



E27



1x 40W



9 002759 439750



H 1100

Ø 380



43656



43657

43656 ROSLEY

spot; steel, black / fabric, linen, natural
Spot; Stahl, schwarz / Textil, Leinen, natur
spot; acier, noir / tissu, lin, nature

H 110, Ø 90, A 185



E14



1x 40W



9 002759 436568

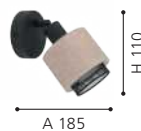

A 185

43657 ROSLEY

spot; steel, black / fabric, linen, natural
Spot; Stahl, schwarz / Textil, Leinen, natur
spot; acier, noir / tissu, lin, nature

L 310, B 90, H 185



E14



2x 40W



9 002759 436575



L 310



43658



43659

43658 ROSLEY

spot; steel, black / fabric, linen, natural
 Spot; Stahl, schwarz / Textil, Leinen, natur
 spot; acier, noir / tissu, lin, nature

L 430, B 90, H 185



E14



3x 40W



9 002759 436582



43659 ROSLEY

spot; steel, black / fabric, linen, natural
 Spot; Stahl, schwarz / Textil, Leinen, natur
 spot; acier, noir / tissu, lin, nature

L 750, B 90, H 185



E14



4x 40W



9 002759 436599





DESIGN
HIGHLIGHT
DETAIL



43934

43934 SURFLEET

table light; steel, black / wood, fabric, natural
Tischleuchte; Stahl, schwarz / Holz, Textil, natur
luminaire de table; acier, noir / bois, tissu, nature

H 515, Ø 200, Base: Ø 210



E27 1x 40W



9 002759 439347



43874 SURFLEET

pendant light; steel, black / wood, fabric, natural
Hängeleuchte; Stahl, schwarz / Holz, Textil, natur
luminaire en suspension; acier, noir / bois, tissu, nature

H 1100, Ø 330



E27 1x 40W



9 002759 438746





43874



VINTAGE

#USED #LOOK

Did you know that the word Vintage originally meant „wine harvest“? Vintage style means a piece of furniture built anew but designed in a „used look“. Genuine vintage pieces from the 1920s to 1980s can be found in flea markets or in the attic, by contrast. Genuine or as imitations: Vintage reminds us of the good old days: summer holidays with the grandparents, the first ride in grandpa’s vintage car and the best apple pie from grandma’s enamelled mould. Travel through time, and enjoy feelings of nostalgia with a glass of wine. We recommend accompanying the wine with a taste of our vintage product range.

Wussten Sie, dass das Wort Vintage ursprünglich „Weinlese“ bedeutet? Vom Vintage-Stil spricht man, wenn ein Einrichtungstück neu gebaut, aber im „Used-Look“ design ist. Echte Vintage-Stücke aus den 20er bis 80er-Jahren findet man hingegen auf Flohmärkten oder am Dachboden. Ob echt oder nachgebaut, Vintage erinnert uns an die gute alte Zeit: Sommerferien bei den Großeltern, die erste Fahrt mit Opas Oldtimer und der beste Apfelkuchen aus Omas Emaille-Form. Erleben Sie eine Zeitreise, schwelgen Sie in Nostalgiegefühlen und schenken Sie sich ein Glas Wein ein. Als Weinbegleitung empfehlen wir ein Reinschnuppern in unsere Vintage-Produktserie.

Est-ce que vous saviez que le mot Vintage voulait originellement dire « vendanges » ? Lorsqu’une pièce de décor est fabriquée à neuf, mais qu’elle est conçue dans le « Used-Look » (look usé), l’on parle de style Vintage. Contrairement, des vraies pièces Vintage, des années 20 jusqu’aux années 80, se trouvent soit sur le marché aux puces, soit au grenier. Qu’elles soient réelles ou imitées, Vintage nous rappelle le bon vieux temps : les vacances d’été chez les grands-parents, la première conduite avec la voiture de collection du grand-père et la meilleure tarte aux pommes du moule en émail de la grand-mère. Découvrez un voyage dans le temps, festoyez dans des sentiments nostalgiques et versez-vous un verre de vin. Nous recommandons, comme accompagnement de vin, un reniflement dans notre série de produit Vintage.



VINOZA
242



KENSAL
242



GARGRAVE
243



BRADFORD
244



BRADFORD 1
245



EDALE
246



TOWNSHEND 2
247



RAMPside
248-250



YOUNGSTOWN
251



WOOTTON
252



KINROSS
253



RODING
254



CHISLE
255



TARLE
256



NIMLET
257



PADSTOW
257



KILBURN
258



STOCKBURY
259



This product is available in different colors and shapes./ Dieser Artikel ist in unterschiedlichen Farben und Formen verfügbar.
Cet article est disponible en différentes couleurs et formes.



43824



43823



43642

43824 VINOZA

table light; ceramic, white / fabric, black
Tischleuchte; Keramik, weiss / Textil, schwarz
luminaire de table; céramique, blanc / tissu, noir

H 535, Ø 300, Base: Ø 120



E27 1x 40W



9 002759 438241

43823 VINOZA

table light; ceramic, black / fabric, white
Tischleuchte; Keramik, schwarz / Textil, weiss
luminaire de table; céramique, noir / tissu, blanc

H 535, Ø 300, Base: Ø 120



E27 1x 40W



9 002759 438234

43642 KENSAL

table light; steel, grey, black / fabric, black
Tischleuchte; Stahl, grau, schwarz / Textil, schwarz
luminaire de table; acier, gris, noir / tissu, noir

H 435, Ø 250, Base: Ø 140



E27 1x 40W



9 002759 436421



43929

43929 GARGRAVE

table light; steel, grey, brushed brass / glass vaporized, black-brown-transparent

Tischleuchte; Stahl, grau, messing-gebürstet / Glas bedampft, schwarz-braun-transparent

luminaire de table; acier, gris, laiton brossé / verre vaporisé, noir-marron-transparent

H 315, Ø 110, Base: Ø 150



E27



1x 40W



9 002759 439293



DESIGN
HIGHLIGHT
DETAIL

DETAIL 43929

The rotary switch can be used to turn the luminaires on and off.

Der Drehschalter kann zum ein- und ausschalten der Leuchten verwendet werden.

Le commutateur rotatif peut être utilisé pour allumer et éteindre les luminaires.





49283



49284



49213

49284 BRADFORD

table light; steel, antique silver / glass, clear
Tischleuchte; Stahl, silber-antik / Glas, klar
luminaire de table; acier, argent antique / verre, transparent

H 330, Ø 140



E27 1x 60W



9 002759 492847



49283 BRADFORD

table light; steel, black / glass, clear
Tischleuchte; Stahl, schwarz / Glas, klar
luminaire de table; acier, noir / verre, transparent

H 330, Ø 140



E27 1x 60W



9 002759 492830



49213 BRADFORD

pendant light; steel, black / glass, clear
Hängeleuchte; Stahl, schwarz / Glas, klar
luminaire en suspension; acier, noir / verre, transparent

H 1100, Ø 140



E27 1x 60W



9 002759 492137





43623

43623 BRADFORD 1

table light; steel, black / glass, clear
Tischleuchte; Stahl, schwarz / Glas, klar
luminaire de table; acier, noir / verre, transparent

L 165, B 150, H 370



E27



1x 60W



9 002759 436230



DESIGN
HIGHLIGHT
DETAIL





43783



43782



43781



43783 EDALE

wall light; steel, wood, black, brown / fabric, cappuccino
Wandleuchte; Stahl, Holz, schwarz, braun / Textil, cappuccino
Applique; acier, bois, noir, marron / tissu, cappuccino

L 150, H 215, A 195



E27



1x 40W



9 002759 437831



L 150

H 215

A 195

43782 EDALE

pendant light; steel, wood, black, brown / fabric, cappuccino
Hängeleuchte; Stahl, Holz, schwarz, braun / Textil, cappuccino
luminaire en suspension; acier, bois, noir, marron / tissu, cappuccino

L 1080, B 510, H 1100



E27



6x 40W



9 002759 437824

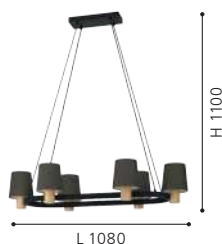

H 1100

L 1080

43781 EDALE

pendant light; steel, wood, black, brown / fabric, cappuccino
Hängeleuchte; Stahl, Holz, schwarz, braun / Textil, cappuccino
luminaire en suspension; acier, bois, noir, marron / tissu, cappuccino

H 1100, Ø 700



E27



6x 40W



9 002759 437817



H 1100

Ø 700



49927

49927 TOWNSHEND 2

pendant light; steel, wood, white-patina / fabric, linen, white, brown

Hängeleuchte; Stahl, Holz, weiss-patina / Textil, Leinen, weiss, braun

luminaire en suspension; acier, bois, blanc patiné / tissu, lin, blanc, marron

L 1000, B 150, H 1100



E27



4x 60W



9 002759 499273

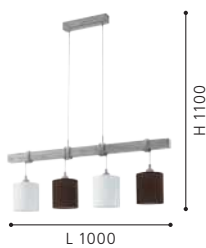



43192



43195

DETAIL 43195

The luminaire heads can be installed on the ceiling individually.
Die Leuchtenköpfe können individuell an die Decke montiert werden.
Les têtes de luminaires peuvent être montées individuellement au plafond.

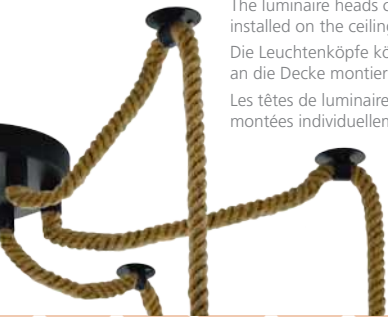

43192 RAMPSIDE

pendant light; steel, black / glass vaporized, amber
Hängeleuchte; Stahl, schwarz / Glas bedampft, amber
luminaire en suspension; acier, noir / verre vaporisé, ambre

L 895, B 195, H 1230



E27 3x 28W



9 002759 431921



43195 RAMPSIDE

pendant light; steel, black
Hängeleuchte; Stahl, schwarz
luminaire en suspension; acier, noir

H 1590, Ø 180



E27 6x 28W



9 002759 431952



43194 RAMPSIDE

pendant light; steel, black
Hängeleuchte; Stahl, schwarz
luminaire en suspension; acier, noir

H 1090, Ø 760



E27 6x 28W



9 002759 431945

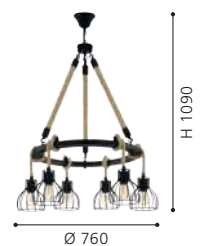



43194



43256



43197

43256 RAMPSIDE

pendant light; steel, black
Hängeleuchte; Stahl, schwarz
luminaire en suspension; acier, noir

H 1380, Ø 110



E27



1x 28W



9 002759 432560



43197 RAMPSIDE

wall light; steel, wood, black, brown
Wandleuchte; Stahl, Holz, schwarz, braun
Applique; acier, bois, noir, marron

L 80, H 300, A 135



E27



1x 28W



9 002759 431976





43318



43319

43318 YOUNGSTOWN

pendant light; steel, wood, black, brown
 Hängeleuchte; Stahl, Holz, schwarz, braun
 luminaire en suspension; acier, bois, noir, marron

L 700, B 45, H 1100



E27



4x 40W



9 002759 433185

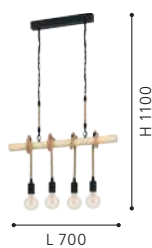

43319 YOUNGSTOWN

pendant light; steel, wood, black, brown
 Hängeleuchte; Stahl, Holz, schwarz, braun
 luminaire en suspension; acier, bois, noir, marron

L 1000, B 45, H 1100



E27



6x 40W



9 002759 433192

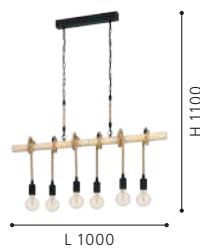

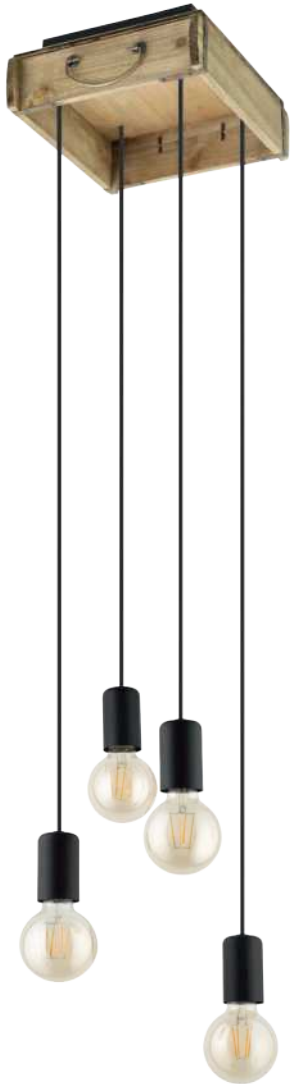

43591



43592



43594

43591 WOOTTON

pendant light; wood, steel, brown, black
 Hängeleuchte; Holz, Stahl, braun, schwarz
 luminaire en suspension; bois, acier, marron, noir

L 250, B 280, H 1100



E27 4x 40W



9 002759 435912

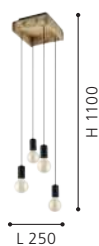

43592 WOOTTON

pendant light; wood, steel, brown, black
 Hängeleuchte; Holz, Stahl, braun, schwarz
 luminaire en suspension; bois, acier, marron, noir

L 810, B 220, H 1100



E27 6x 40W



9 002759 435929



43594 WOOTTON

table light; wood, steel, brown, black
 Tischleuchte; Holz, Stahl, braun, schwarz
 luminaire de table; bois, acier, marron, noir

L 250, B 220, H 375



E27 3x 40W



9 002759 435943





49724

49724 KINROSS

pendant light; steel, brown / wood, brown
Hängeleuchte; Stahl, braun / Holz, braun
luminaire en suspension; acier, marron / bois, marron

H 1100, Ø 310



E27



1x 60W



9 002759 497248



H 1100

Ø 310





43619



43618

43619 RODING

wall light; steel, wood, black, brown / glass, clear
 Wandleuchte; Stahl, Holz, schwarz, braun / Glas, klar
 Applique; acier, bois, noir, marron / verre, transparent

L 180, H 350, A 180



E27



1x 40W



9 002759 436193



43618 RODING

pendant light; steel, wood, black, brown / glass, clear
 Hängeleuchte; Stahl, Holz, schwarz, braun / Glas, klar
 luminaire en suspension; acier, bois, noir, marron / verre, transparent

L 880, B 180, H 1100



E27



3x 40W



9 002759 436186





43527



43499



43528



DETAIL CHISLE

The mixture of steel and vaporized glass gives these luminaires a unique look.

Die Mischung aus Stahl und bedampftem Glas verleiht diesen Leuchten eine besondere Optik.

Le mélange d'acier et de verre vaporisé donne à ces luminaires un look unique.

43527 CHISLE

pendant light; steel, black, bronzed / glass vaporized, amber

Hängeleuchte; Stahl, schwarz, brüniert / Glas bedampft, amber

luminaire en suspension; acier, noir, brun / verre vaporisé, ambre

H 1100, Ø 165



E27



1x 40W



9 002759 435271

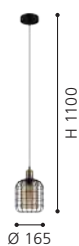

43499 CHISLE

pendant light; steel, black, bronzed / glass vaporized, amber

Hängeleuchte; Stahl, schwarz, brüniert / Glas bedampft, amber

luminaire en suspension; acier, noir, brun / verre vaporisé, ambre

H 1300, Ø 425



E27



3x 40W



9 002759 434991



43528 CHISLE

pendant light; steel, black, bronzed / glass vaporized, amber

Hängeleuchte; Stahl, schwarz, brüniert / Glas bedampft, amber

luminaire en suspension; acier, noir, brun / verre vaporisé, ambre

L 1300, B 165, H 1100



E27



4x 40W



9 002759 435288

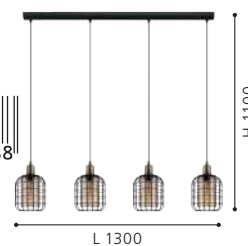



43845

43845 TARLE

pendant light; steel, black
Hängeleuchte; Stahl, schwarz
luminaire en suspension; acier, noir

H 1100, Ø 445



E14



3x 40W



9 002759 438456

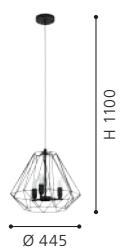



44088



43653

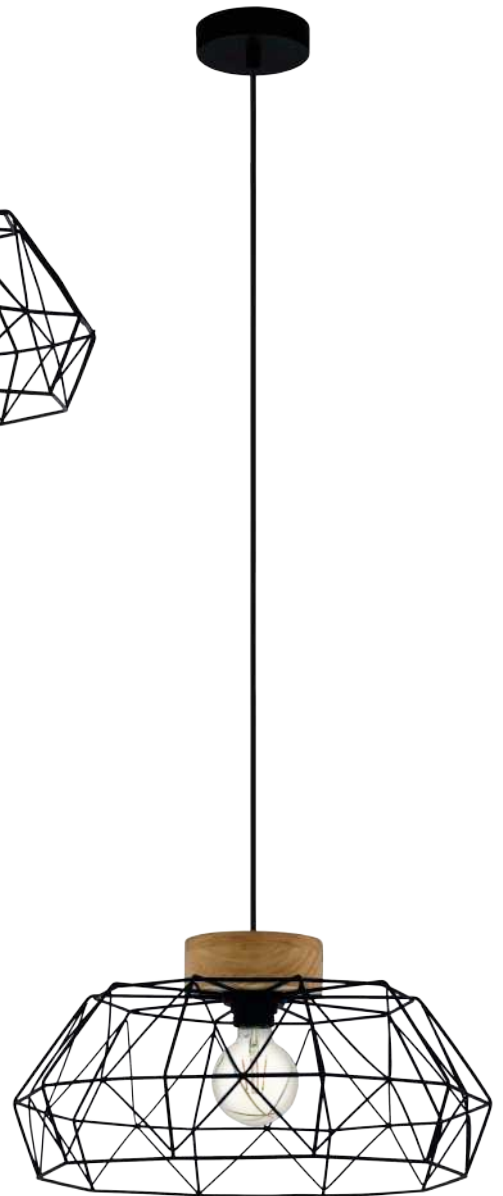

44089



43653 NIMLET

table light; steel, black / fabric, black
Tischleuchte; Stahl, schwarz / Textil, schwarz
luminaire de table; acier, noir / tissu, noir

H 515, Ø 300, Base: Ø 135



E27 1x 40W



9 002759 436537



44088 PADSTOW

ceiling light; steel, wood, black, natural
Deckenleuchte; Stahl, Holz, schwarz, natur
plafonnier; acier, bois, noir, naturel

H 205, Ø 455



E27 1x 60W



9 002759 440886



44089 PADSTOW

pendant light; steel, wood, black, natural
Hängeleuchte; Stahl, Holz, schwarz, natur
luminaire en suspension; acier, bois, noir, naturel

H 1100, Ø 455



E27 1x 60W



9 002759 440893

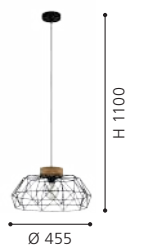



43922



43921



43923



43921 KILBURN

spot; wood, brown / steel, white, brown
Spot; Holz, braun / Stahl, weiss, braun
spot; bois, marron / acier, blanc, marron

L 120, H 185, A 160



E27



1x 40W



9 002759 439217



43922 KILBURN

spot; wood, brown / steel, white, brown
Spot; Holz, braun / Stahl, weiss, braun
spot; bois, marron / acier, blanc, marron

L 360, H 170, A 160



E27



2x 40W



9 002759 439224



43923 KILBURN

spot; wood, brown / steel, white, brown
Spot; Holz, braun / Stahl, weiss, braun
spot; bois, marron / acier, blanc, marron

L 590, H 170, A 160



E27



3x 40W



9 002759 439231





49456

49456 STOCKBURY

pendant light; steel, antique brown, beige
Hängeleuchte; Stahl, antik-braun, beige
luminaire en suspension; acier, marron antique, beige

H 1100, Ø 360



E27



1x 60W



9 002759 494568

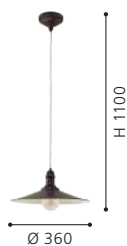

DESIGN
HIGHLIGHT
DETAIL



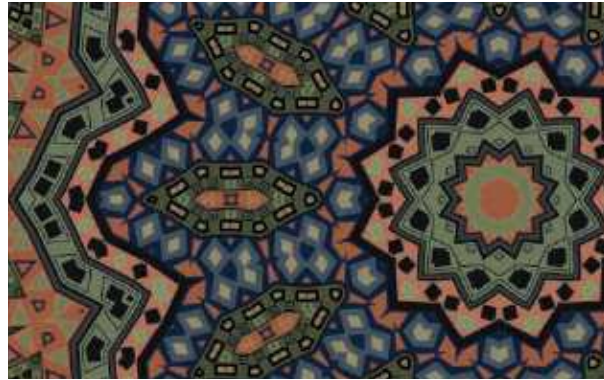

ETHNO ELEGANCE

#EXOTIC
#ORIENT

A little Orient, a bit of Africa, a touch of Latin America – but nothing common at all! These lamps let you dive into a world of exotic markets with spices, colours and shapes. Bring fairy-tale moments from remote countries to your home – with Ethno Elegance.

Ein bisschen Orient, ein wenig Afrika, ein Hauch Lateinamerika – nur nichts Gewöhnliches! Mit diesen Leuchten tauchen Sie ein in eine Welt exotischer Märkte mit Gewürzen, Farben und Formen. Holen Sie märchenhafte Momente aus fernen Ländern zu sich nach Hause – mit Ethno Elegance.

Un peu oriental, un peu africain, une touche d'Amérique latine – surtout rien d'ordinaire ! Grâce à ces luminaires, vous entrez dans un monde de marchés exotiques avec des épices, des couleurs et des formes. Apportez des moments féériques dans votre maison, venant de pays lointains – grâce à Ethno Elegance.



GRIZEDALE
262



FELIXKIRK
262



MUMBLES
265

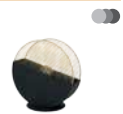

SANDBACH
266



JADIDA
268



TALBOT 2
268



STAVERTON
269



BRIDEKIRK
269



This product is available in different colors and shapes./ Dieser Artikel ist in unterschiedlichen Farben und Formen verfügbar.
Cet article est disponible en différentes couleurs et formes.

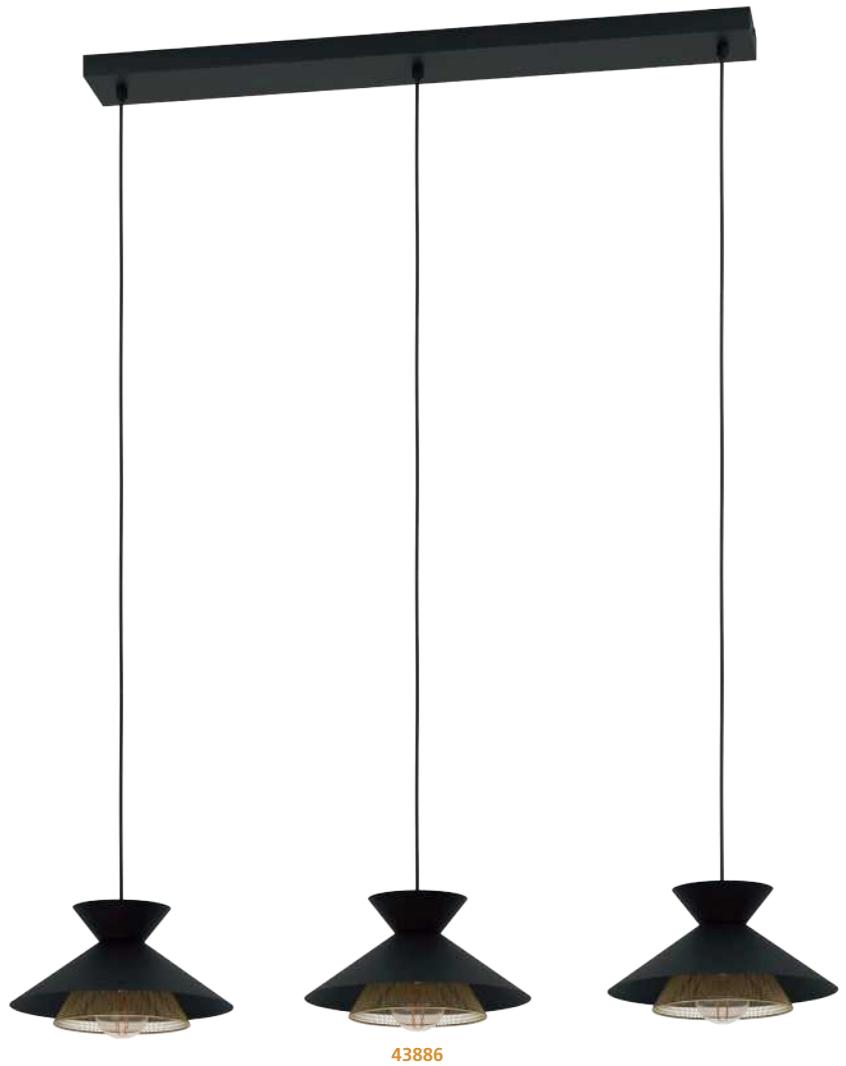
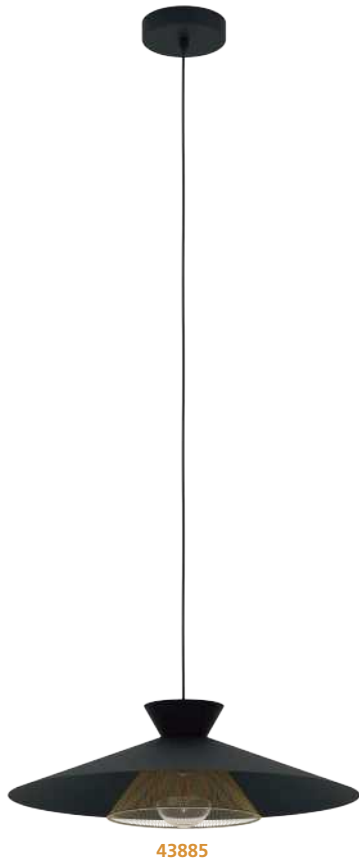

43885 GRIZEDALE

pendant light; steel, black, brass
 Hängeleuchte; Stahl, schwarz, messing
 luminaire en suspension; acier, noir, laiton

H 1100, Ø 500



E27 1x 40W



9 002759 438852

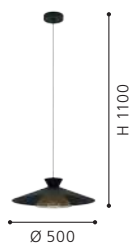

43886 GRIZEDALE

pendant light; steel, black, brass
 Hängeleuchte; Stahl, schwarz, messing
 luminaire en suspension; acier, noir, laiton

L 960, B 260, H 1100



E27 3x 40W



9 002759 438869

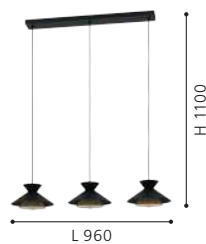

43931 FELIXKIRK

pendant light; steel, black / steel, black, gold
 Hängeleuchte; Stahl, schwarz / Stahl, schwarz, gold
 luminaire en suspension; acier, noir / acier, noir, or

H 1100, Ø 570



E27 1x 40W



9 002759 439316





43931





43813

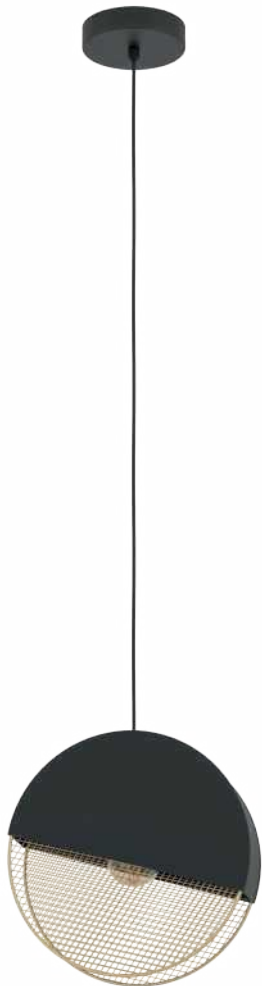

43811



43812

43813 MUMBLES

table light; steel, black, gold
Tischleuchte; Stahl, schwarz, gold
luminaire de table; acier, noir, or

L 280, B 90, H 285, Base: Ø 170



E27 1x 40W



9 002759 438135



43811 MUMBLES

pendant light; steel, black, gold
Hängeleuchte; Stahl, schwarz, gold
luminaire en suspension; acier, noir, or

L 285, B 90, H 1100



E27 1x 40W



9 002759 438111



43812 MUMBLES

pendant light; steel, black, gold
Hängeleuchte; Stahl, schwarz, gold
luminaire en suspension; acier, noir, or

L 860, B 90, H 1100



E27 2x 40W



9 002759 438128

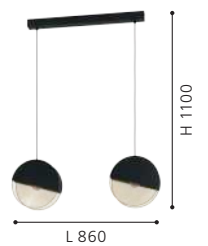



43979



43982

43979 SANDBACH

ceiling light; steel, black, brass
Deckenleuchte; Stahl, schwarz, messing
plafonnier; acier, noir, laiton

H 220, Ø 420



E27 1x 40W



9 002759 439798

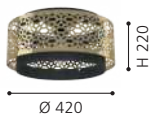

43982 SANDBACH

table light; steel, black, brass
Tischleuchte; Stahl, schwarz, messing
luminaire de table; acier, noir, laiton

H 450, Ø 240, Base: Ø 200



E27 1x 40W



9 002759 439828



43981 SANDBACH

pendant light; steel, black, brass
Hängeleuchte; Stahl, schwarz, messing
luminaire en suspension; acier, noir, laiton

H 1100, Ø 420



E27 1x 40W



9 002759 439811





43981





49764



49717



DESIGN
HIGHLIGHT
DETAIL

49764 JADIDA

pendant light; steel, antique copper coloured / glass, coloured
Hängeleuchte; Stahl, kupferfarben-antik / Glas, bunt
luminaire en suspension; acier, cuivré antique / verre, coloré

H 1100, Ø 330



E27



1x 60W



9 002759 497644



49717 TALBOT 2

pendant light; steel, antique white
Hängeleuchte; Stahl, weiss-antik
luminaire en suspension; acier, blanc antique

H 1100, Ø 295



E27



1x 60W



9 002759 497170



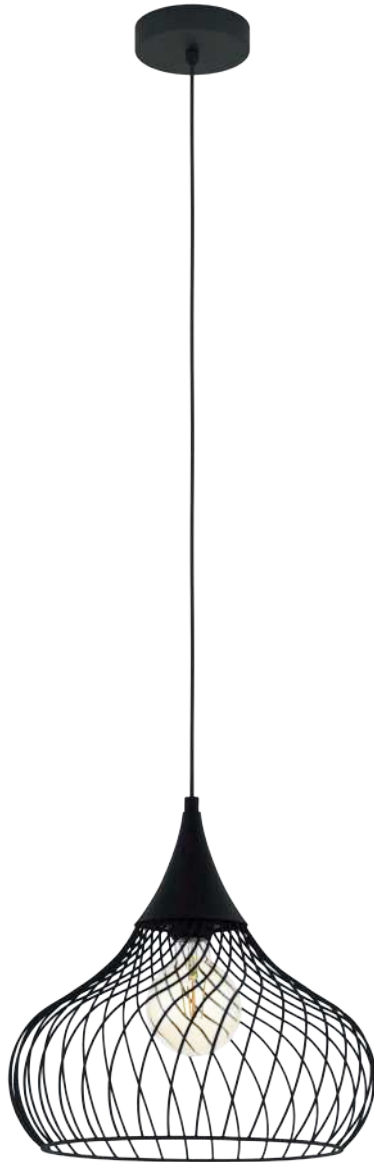

43344

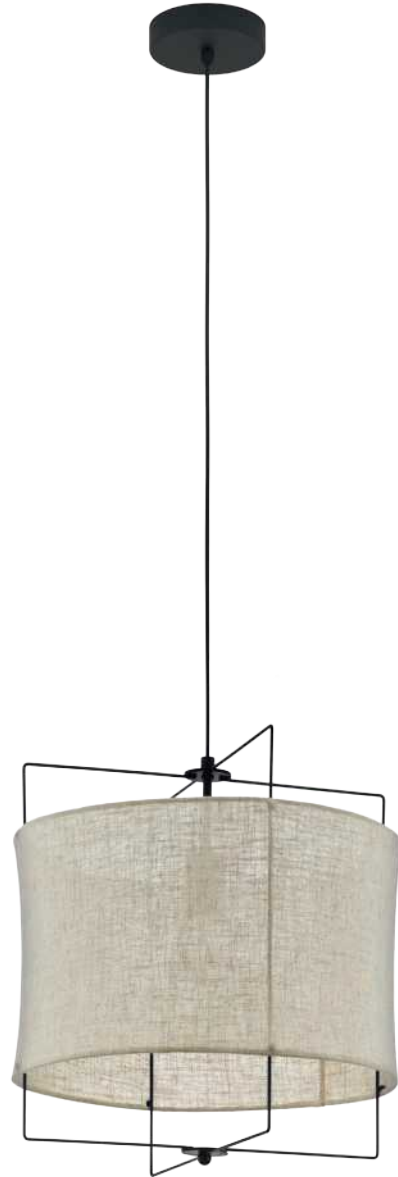

43292

43344 STAVERTON

pendant light; steel, black
 Hängeleuchte; Stahl, schwarz
 luminaire en suspension; acier, noir

H 1100, Ø 365



E27



1x 60W



9 002759 433444

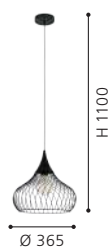

43292 BRIDEKIRK

pendant light; steel, black / fabric, linen, natural
 Hängeleuchte; Stahl, schwarz / Textil, Leinen, natur
 luminaire en suspension; acier, noir / tissu, lin, nature

H 1100, Ø 400



E27



1x 40W



9 002759 432928





SOCKETS & ILLUMINANTS

#BRIGHT
#LIGHT

Minimalism at its best! The SOCKET series by EGLO comes in a variety of styles: from a discreet brass ring attachment to a gritty industrial finish. The most important thing is to choose the best light source to skilfully present the luminaire in its best light.

Minimalismus pur! So präsentiert sich die SOCKET-Serie von EGLO in verschiedenen Stilen: Ob mit dezentem Messingring oder grober Industrial-Haptik. Wichtig bleibt dabei die Wahl des richtigen Leuchtmittels, um die Fassung gekonnt in Szene zu setzen.

Le minimalisme à l'état pur ! Voici comment se présente la série SOCKET d'EGLO dans différents styles : avec un discret anneau en laiton ou une structure rugueuse à l'esprit industriel. L'essentiel est de bien choisir l'ampoule afin de mettre habilement la douille en valeur.

CRANLEY 272 	CRANLEY 1 272 	YORTH 273-274 	CALARI 274 	110051 277 	110052 277 	110053 277 	110058 278 
110055 278 	110057 278 	110079 281 	110083 281 	110091 281 	110094 282 	110085 282 	110088 282 
110029 283 	110031 283 	12552 286 	12553 286 	12554 287 	12588 287 	110268 289 	110267 289 
110233 291 	110234 291 	110109 292 	110111 292 	110112 293 			





43758

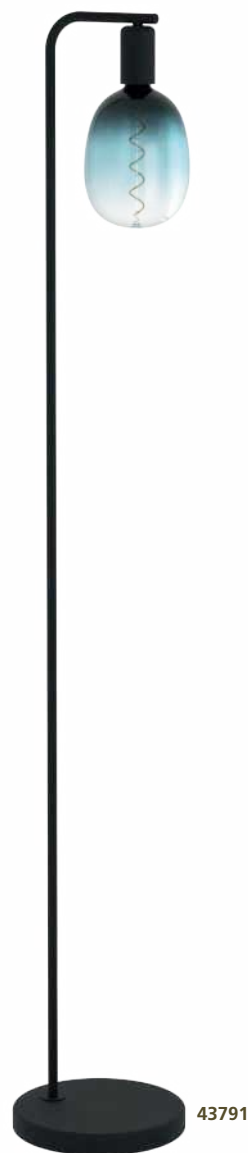

43791

43758 CRANLEY

floor light; steel, black
 Stehleuchte; Stahl, schwarz
 lampadaire; acier, noir

L 430, B 60, H 1700, Base: Ø 300



E27



1x 40W



L 430



9 002759 437589

43791 CRANLEY 1

floor light; steel, black
 Stehleuchte; Stahl, schwarz
 lampadaire; acier, noir

H 1485, Base: Ø 230



E27



1x 40W



H 1485



9 002759 437916



43803



43802



43801



DESIGN
HIGHLIGHT
DETAIL

43803 YORTH

pendant light; steel, black, bronzed
Hängeleuchte; Stahl, schwarz, brüniert
luminaire en suspension; acier, noir, brun

H 1500, Ø 50



E27 1x 40W



9 002759 438036



43802 YORTH

pendant light; steel, black, silver
Hängeleuchte; Stahl, schwarz, silber
luminaire en suspension; acier, noir, argent

H 1500, Ø 50



E27 1x 40W



9 002759 438029



43801 YORTH

pendant light; steel, nickel-nero, black
Hängeleuchte; Stahl, nickel-nero, schwarz
luminaire en suspension; acier, nickel brillant, noir

H 1500, Ø 50



E27 1x 40W



9 002759 438012





32539



31075

32539 YORTH

pendant light; steel, brushed copper
 Hängeleuchte; Stahl, kupfer-gebürstet
 luminaire en suspension; acier, cuivre brossé

H 2000, Ø 100



E27 1x 60W



9 002759 325398

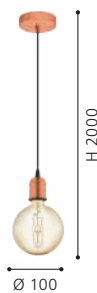

31075 CALARI

pendant light; steel, black, brass
 Hängeleuchte; Stahl, schwarz, messing
 luminaire en suspension; acier, noir, laiton

H 1500, Ø 45



E27 1x 40W



9 002759 310752



31073 CALARI

pendant light; steel, black
 Hängeleuchte; Stahl, schwarz
 luminaire en suspension; acier, noir

L 95, B 65, H 1500



E27 1x 40W



9 002759 310738





31073



AMBER

LED FILAMENT ILLUMINANTS

AMBER

LED FILAMENT ILLUMINANTS

- › Perfect look for retro luminaires
- › Pleasant ambience
- › Sufficient all-round lighting
- › Low energy costs at only 4W energy consumption

AMBER

LED FILAMENT LEUCHTMITTEL

- › Perfekter Look bei Retro-Leuchten
- › Angenehmes Ambiente
- › Ausreichende Rundumbeleuchtung
- › Niedrige Energiekosten bei nur 4W Stromverbrauch

AMBER

AMPOULES DEL À FILÀMENT

- › Un aspect parfait pour les luminaires rétro
- › Atmosphère agréable
- › éclairage suffisant tout autour
- › Faibles coûts énergétiques avec une consommation de seulement 4W



110051 E27-LED-A75



L 130, Ø 75	not dimmable	80 CRI
4 W	15000 h	
220-240V, 50/60Hz	8	
E27	4 W ~ 32 W	9 008606 227853



110052 E27-LED-G80



L 120, Ø 80	not dimmable	80 CRI
4 W	15000 h	
220-240V, 50/60Hz	4	
E27	4 W ~ 32 W	9 008606 227860



110053 E27-LED-G95



L 140, Ø 95	not dimmable	80 CRI
4 W	15000 h	
220-240V, 50/60Hz	4	
E27	4 W ~ 31 W	9 008606 227877



110058 E14-LED-C35



 **270 lm**  **warm WHITE** **2200 K**  **A+ G**

 L 98, Ø 35	 not dimmable	 80 CRI
 4 W	 15000 h	
 220-240V, 50/60Hz	 8	
 E14	 4 W ~ 26 W	 9 008606 227921



110055 E27-LED-ST64











 **270 lm**  **warm WHITE** **2200 K**  **A+ G**

 L 142, Ø 64	 not dimmable	 80 CRI
 4 W	 15000 h	
 220-240V, 50/60Hz	 8	
 E27	 4 W ~ 26 W	 9 008606 227891



110057 E27-LED-T30

 **350 lm**  **warm WHITE** **2200 K**  **A+ F**

 L 185, Ø 30	 not dimmable	 80 CRI
 4 W	 15000 h	
 220-240V, 50/60Hz	 8	
 E27	 4 W ~ 32 W	 9 008606 227914





DECORATIVE SPIRAL

LED FILAMENT ILLUMINANTS

DECORATIVE SPIRAL

LED FILAMENT ILLUMINANTS

- › Extraordinary LED shape
- › Sufficient all-round lighting
- › Low energy consumption with only 4 watt power
- › Sets your luminaire perfectly in scene

DECORATIVE SPIRAL

LED FILAMENT LEUCHTMITTEL

- › Außergewöhnliche Form der LED
- › Ausreichende Rundumbeleuchtung
- › Niedrige Energiekosten bei nur 4 Watt Leistung
- › Setzt Ihre Leuchte perfekt in Szene

DECORATIVE SPIRAL

AMPOULES DEL À FILÀMENT

- › Forme de la DEL hors du commun
- › Éclairage rond suffisant
- › Faible coût énergétique avec seulement 4 watts de puissance
- › Met votre luminaire parfaitement en scène

110079 E27-LED-G80



245 lm	warm WHITE	2000 K	
L 120, Ø 80	dimmable	80 CRI	
4 W	15000 h		
220-240V, 50/60Hz	4		
E27	4 W ~ 25 W		



110083 E27-LED-ST64



245 lm	warm WHITE	2000 K	
L 142, Ø 64	dimmable	80 CRI	
4 W	15000 h		
220-240V, 50/60Hz	8		
E27	4 W ~ 25 W		



110091 E27-LED-G80













30 lm	warm WHITE	2000 K	
L 120, Ø 80	dimmable	66 CRI	
4 W	15000 h		
220-240V, 50/60Hz	4		
E27	4 W ~ 3 W		





110094 E27-LED-ST64











 **30 lm**  warm **2000 K** 

 L 142, Ø 64	 dimmable	 66 CRI
 4 W	 15000 h	
 220-240V, 50/60Hz	 8	
 E27	 4 W ~ 3 W	 9 008606 228249



110085 E27-LED-G80











 **100 lm**  warm **2000 K** 

 L 120, Ø 80	 dimmable	 82 CRI
 4 W	 15000 h	
 220-240V, 50/60Hz	 4	
 E27	 4 W ~ 11 W	 9 008606 228164



110088 E27-LED-ST64

 **100 lm**  warm **2000 K** 

 L 142, Ø 64	 dimmable	 82 CRI
 4 W	 15000 h	
 220-240V, 50/60Hz	 8	
 E27	 4 W ~ 11 W	 9 008606 228195

110029 E27-LED-A60



806 lm



2700 K



L 106, Ø 60



not dimmable



80 CRI



7.3 W



25000 h



220-240V, 50/60Hz



8



E27



7.3 W ~ 60 W



110031 E27-LED-A60



806 lm



2700 K



L 106, Ø 60



not dimmable



80 CRI



7.3 W



25000 h



220-240V, 50/60Hz



8



E27



7.3 W ~ 60 W



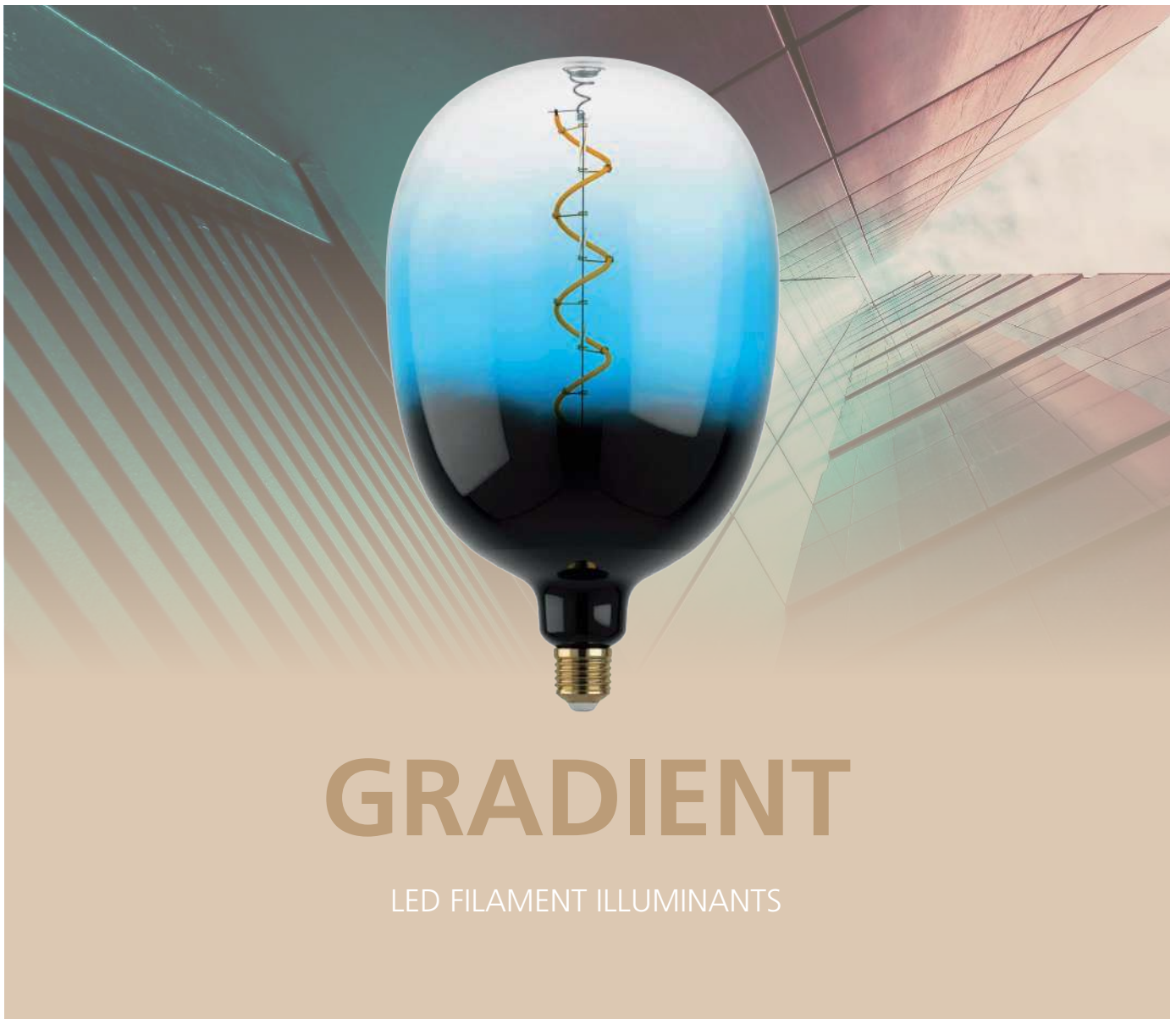

GRADIENT

LED FILAMENT ILLUMINANTS

GRADIENT

LED FILAMENT ILLUMINANTS

- › Sophisticated, novel Shapes
- › Aesthetic variety
- › Perfectly combinable
- › Dimmable
- › Available in 4 colors

GRADIENT

LED FILAMENT LEUCHTMITTEL

- › Raffinierte, neuartige Formen
- › Ästhetischer Farbverlauf
- › Perfekt kombinierbar
- › Dimmbar
- › Verfügbar in 4 Farben

GRADIENT

AMPOULES DEL À FILÀMENT

- › Formes sophistiquées et nouvelles
- › Variété esthétique
- › Parfaitement combinable
- › Gradable
- › Disponible en 4 couleurs



BEST CHOICE

This button marks discontinued items that are sold at the best price.

Dieser Button markiert Auslaufartikel, die zum Bestpreis abgegeben werden.

Ce bouton met en évidence les articles de fin de série qui sont cédés au meilleur prix.



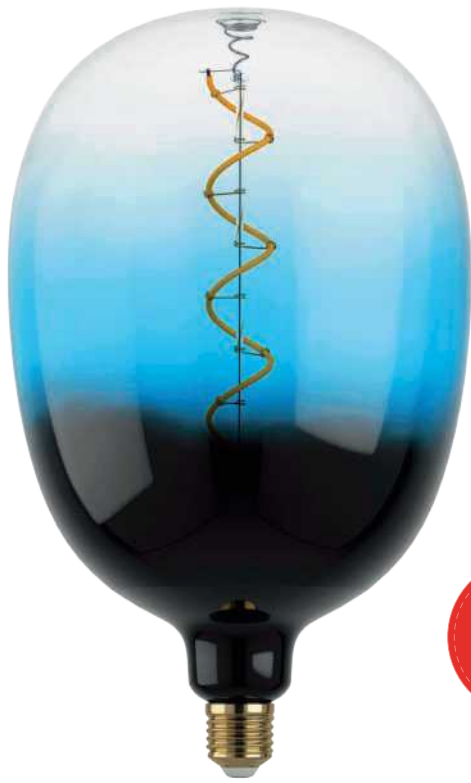

12552 E27-LED-T180

85 lm	warm WHITE	2000 K	
L 295, Ø 180	4 W ~ 10 W		
4 W	80 CRI		
220-240V, 50/60Hz			
E27			
dimmable			
25000 h	9 002759 125523		













12553 E27-LED-T180

100 lm	warm WHITE	1700 K	
L 295, Ø 180	4 W ~ 11 W		
4 W	80 CRI		
220-240V, 50/60Hz			
E27			
dimmable			
25000 h	9 002759 125530		













12554 E27-LED-T180

 85 lm	warm WHITE	1800 K	
 L 295, Ø 180	 4 W ~ 10 W		
 4 W	 80 CRI		
 220-240V, 50/60Hz			
 E27			
 dimmable			
 25000 h	 9 002759 125547		



12588 E27-LED-T180

 85 lm	warm WHITE	1800 K	
 L 295, Ø 180	 4 W ~ 10 W		
 4 W	 80 CRI		
 220-240V, 50/60Hz			
 E27			
 dimmable			
 25000 h	 9 002759 125882		



NEW DECORATIVE

LED FILAMENT ILLUMINANTS

NEW DECORATIVE

LED FILAMENT ILLUMINANTS

- › Elegantly arranged LED filaments
- › Modern designs for sophisticated decorative lighting
- › Low energy costs with 4 Watt output
- › New coatings provide first class colours

NEU DECORATIVE

LED FILAMENT LEUCHTMITTEL

- › Elegant angeordnete LED Filaments
- › Moderne Designs für anspruchsvolle Dekorativbeleuchtung
- › Niedrige Energiekosten bei 4 Watt Leistung
- › Neue Beschichtungen sorgen für erstklassige Farben

NOUVEAU DÉCORATIF

AMPOULES DEL À FILÀMENT

- › Filaments LED élégamment disposés
- › Designs modernes pour un éclairage décoratif sophistiquéFaibles coûts
- › Énergétiques pour une puissance de 4 watts
- › De nouveaux revêtements assurent des couleurs de première qualité



110268 E27-LED-G125

NEW



40 lm

warm
WHITE

2000 K



L 180, Ø 125



4 W ~ 6 W



4 W



80 CRI



220-240V, 50/60Hz



E27



dimable



25000 h



9 008606 267200



110267 E27-LED-G190

NEW



40 lm

warm
WHITE

2000 K



L 255, Ø 190



4 W ~ 6 W



4 W



80 CRI



220-240V, 50/60Hz



E27



dimable



25000 h



9 008606 267194



BIG SIZE

LED FILAMENT ILLUMINANTS

BIG SIZE

LED FILAMENT ILLUMINANTS

- › Extra-large shape
- › An eye-catcher in your living area
- › Your illuminant becomes a luminaire
- › Dimmable

BIG SIZE

LED FILAMENT LEUCHTMITTEL

- › Extra große Form
- › Der Blickfang in Ihrem Wohnbereich
- › Ihr Leuchtmittel wird zur Leuchte
- › Dimmbar







BIG SIZE

AMPOULES DEL À FILÀMENT

- › Forme extra grande
- › L'attrape œil dans votre espace d'habitat
- › Votre illuminant devient un luminaire
- › réglable













110233 E27-LED-D165

 220 lm	warm WHITE	1800 K	
 H 280, Ø 165	 4 W ~ 22 W		
 4 W	 90 CRI		
 220-240V, 50/60Hz			
 E27			
 dimmable			
 15000 h	 9 008606 242900		



110234 E27-LED-D165

 70 lm	warm WHITE	1800 K	
 H 280, Ø 165	 4 W ~ 9 W		
 4 W	 90 CRI		
 220-240V, 50/60Hz			
 E27			
 dimmable			
 15000 h	 9 008606 242917		

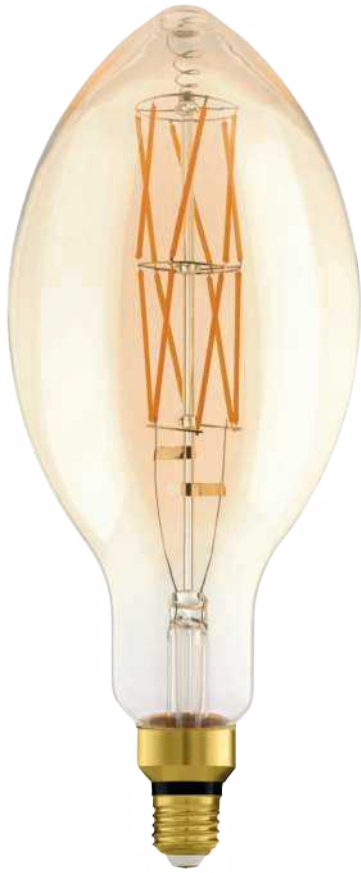

110109 E27-LED-E140



806 lm



2100 K



L 340, Ø 140



8 W ~ 60 W



8 W



80 CRI



220-240V, 50/60Hz



E27



dimnable



15000 h



110111 E27-LED-PS160



806 lm



2100 K



L 320, Ø 160



8 W ~ 60 W



8 W



80 CRI



220-240V, 50/60Hz



E27



dimnable



15000 h







110112 E27-LED-G200

 **806 lm**  **warm WHITE** **2100 K**  **A++ G F**

 L 305, Ø 200

 8 W ~ 60 W

 8 W

 80 CRI

 220-240V, 50/60Hz

 E27

 dimmable

 15000 h

